

# dB

THE SOUND ENGINEERING MAGAZINE

JUNE 1973 \$1.00

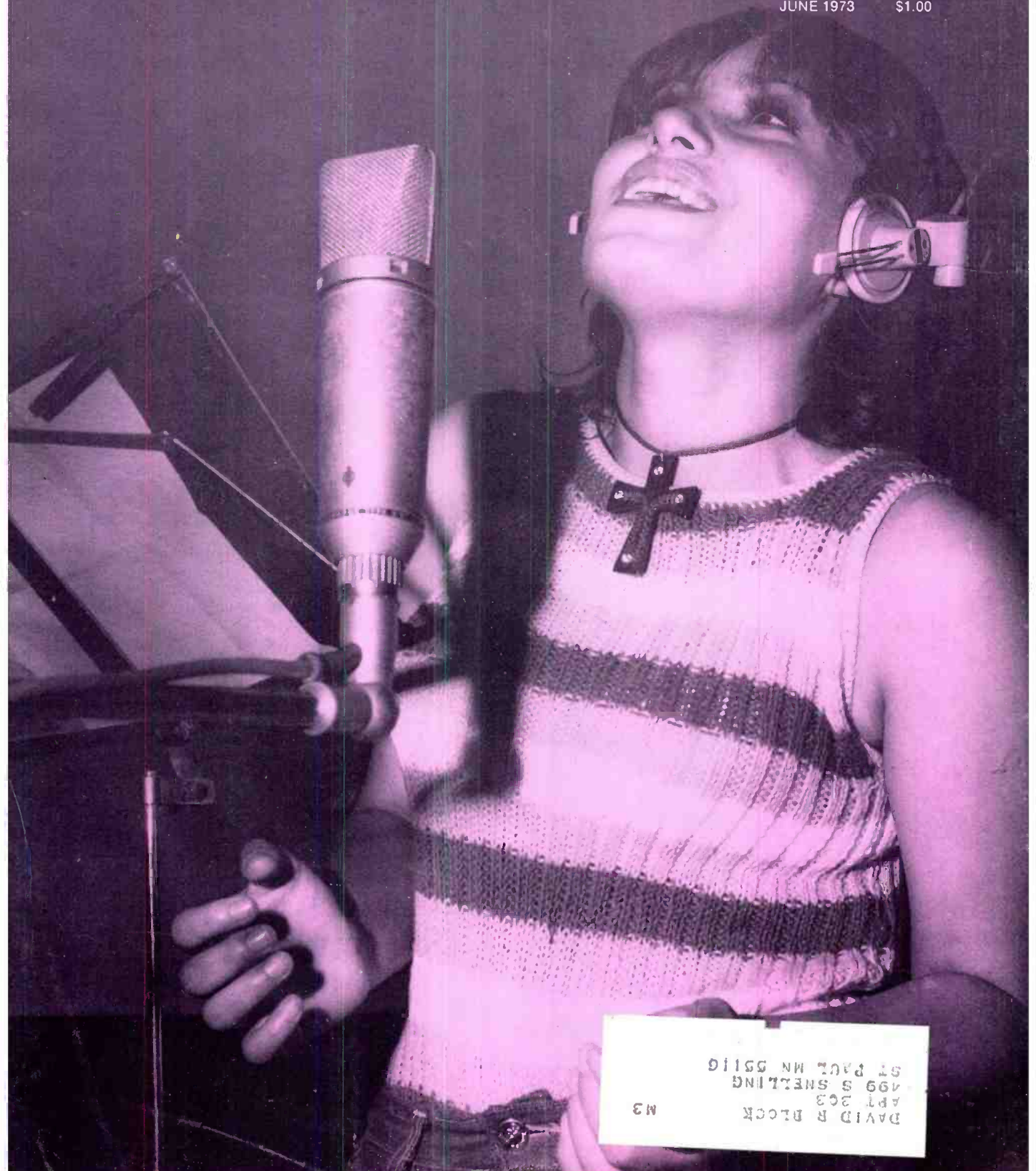

DAVID R BLOCK  
APT 303  
499 S SWEETLING  
ST PAUL MN 55116  
M3

# Sorry, but you'll have to wait for the biggest advance in reverberation.

We've really been flooded with orders for the new EMT 240.

So, we can't promise you delivery until Fall.

But we can promise you this, right now:

The EMT 240 — even though it's approximately *one-eighth* the size of its EMT 140 predecessor, — provides a significant, audible *reduction* in sound coloration.

It will end, once and for all, any thought you've had that it's still necessary to compromise with quality in order to get reduced size.

And you don't have to whisper or tip-toe past the EMT 240. It's impervious to virtually every roar and rumble. So you can use it in your studio, control room, or on location.

Reverb time? It goes down to under one second.

Set-up time? Next to zero. It arrives pre-aligned, pre-tensioned — and, after unpacking, it's prepared to go to work.

Any other questions? Mail the coupon; we'll refer your inquiry to one of our selected franchised dealers. And we'll also send you a 6-page technical treatise on the theory behind this remarkable unit. So write today, won't you?

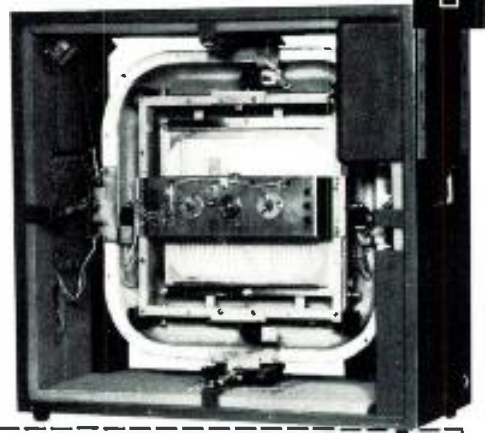

Staple this coupon to your company letterhead,  
and mail to our New York office.

**GOTHAM**  
AUDIO CORPORATION

Headquarters: 741 Washington St.  
New York, NY 10014 Tel: (212) 741-7411  
West Coast Sales Office: 1710 N. La Brea Ave.  
Hollywood, CA 90046 Tel: (213) 874-4444

Please send me your complimentary technical  
treatise describing the theory behind the EMT 240.

NAME \_\_\_\_\_

TITLE \_\_\_\_\_

# COMING NEXT MONTH

• Microphones occupy our editorial pages next month. Anthony Benson has contributed an article on a simple high quality mic preamplifier. If you've taken this product for granted, you may be awakened by this piece. Douglas Easton's **LICK THE CLUTTER SYNDROME** tells of ways to eliminate the vertical standing jungle that often trips up everyone who enters the studio. There are ways. Learn some next month.

Lou Burroughs definitive book on microphones is nearing editorial completion. As a teaser we will publish an important chapter next month. The book itself is coming in the fall. Watch our pages for advance announcements next month.

And there will be our usual columnists: George Alexandrovich (on leave of absence), Norman H. Crowhurst, Martin Dickstein, and John Woram. Coming in **db**, The Sound Engineering Magazine.

# ABOUT THE COVER

• This attractive young performer is well known in Latin America. Read about the adventures of a Peruvian multitrack studio in which she records, beginning on page 20.

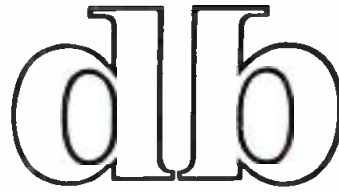

THE SOUND ENGINEERING MAGAZINE

JUNE 1973 VOLUME 7, NUMBER 6

18	db VISITS—RUPERT NEVE John Borwick
20	A MODERN RECORDING STUDIO FOR PERU Gerhard H. Nieckau
25	LOUDNESS—APPLICATIONS AND IMPLICATIONS TO AUDIO, PART 2 Floyd E. Toole
2	THE SYNC TRACK John Woram
8	THEORY AND PRACTICE Norman H. Crowhurst
omitted this month	SOUND WITH IMAGES Martin Dickstein
14	NEW PRODUCTS AND SERVICES
29	BOOKCASE
30	CLASSIFIED
32	PEOPLE, PLACES, HAPPENINGS

**db** is listed in Current Contents: Engineering and Technology,

<b>Robert Bach</b> PUBLISHER	<b>Larry Zide</b> EDITOR
<b>Bob Laurie</b> ART DIRECTOR	<b>John Woram</b> ASSOCIATE EDITOR
<b>A. F. Gordon</b> CIRCULATION MANAGER	<b>Hazel Krantz</b> COPY EDITOR
<b>Eloise Beach</b> ASST. CIRCULATION MGR.	<b>Richard L. Lerner</b> ASSISTANT EDITOR
<b>GRAPHICS Crescent Art Service</b>	

db, The Sound Engineering Magazine is published monthly by Sagamore Publishing Company, Inc. Entire contents copyright © 1973 by Sagamore Publishing Co., Inc., 980 Old Country Road, Plainview, L.I., N.Y. 11803. Telephone (516) 433 6530. db is published for those individuals and firms in professional audio-recording, broadcast, audio-visual, sound reinforcement, consultants, video recording, film sound, etc. Application should be made on the subscription form in the rear of each issue. Subscriptions are \$6.00 per year (\$7.00 per year outside U. S. Possessions, Canada, and Mexico) in U. S. funds. Single copies are \$1.00 each. Controlled Circulation postage paid at Harrisburg, Pa. 17105. Editorial, Publishing, and Sales Offices: 980 Old Country Road, Plainview, New York 11803. Postmaster: Form 3579 should be sent to above address.

John M. Woram

# THE SYNC TRACK

● At last, the National Council of Recording Engineers is ready for members. Herewith, a few notes on what it's all about.

Over a year ago, there were a series of meetings, at which a group of recording engineers compared notes on a variety of subjects; 16 *versus* 24 tracks, new equipment needs, and so on. At the recent A. E. S. convention, some of us got together again to talk about 30 in./sec. alignment procedures, and a recommendation for a multi-pin plug [to replace a bushel basket full of 3-pin plugs].

As these various discussions progressed, it became clear that each problem subject had a variety of solutions. Also, with the proliferation of new equipment and procedures there is much additional room for confusion, especially since tapes have a way of travelling across the country these days.

A few folks thought it would not be a bad idea if recording engineers could exert a little more influence on the direction in which our technology is moving. There was a general feeling that some manufacturers were more interested in playing "Can you top this?" with other manufacturers than in attending to the needs of the customer.

On the other hand, assuming a manufacturer is actually interested in meeting his customers' needs, (some are) it is still awfully difficult to communicate with individual buyers spread out across the country—and perhaps across the globe. And, when each customer is pursuing his own path, and solving his own problems all by himself, the confusion factor becomes formidable indeed.

So, a group of adventurous souls have now formed the National Council of Recording Engineers. It's purpose; to sift through the complexities of the recording industry, and offer its membership some guidelines and standards. And, after analyzing its members' needs and interests, the NCRE will offer the interested manufacturer a valuable source for group feedback.

If you are having trouble with a piece of equipment, let the NCRE know about it. Chances are, others are having the same problem. But you don't know about their troubles, and they don't know about yours. The NCRE will collate *trouble reports* and attempt to communicate with in-

terested manufacturers whenever a consistent trouble spot shows up.

Or, someone may have found out the hard way that after six months of use, the whatchamacallit goes up in smoke. If you're thinking of buying one, the NCRE may be able to give you a list of previous purchasers whom you may want to contact first.

There are a variety of ways to align a multi-track machine for 30 in./sec. operation. The NCRE will publish an alignment procedure which will be sent to all members. When this procedure is used, make a note of it on the tape box. Then, if and when the tape travels to another studio, the engineer there will know exactly how to set up his equipment.

What about 24-track machines? Would you like to know what the other studios think? Before buying a 24-track machine, it may be well to think about a sync system that would allow you to run additional machines in sync with your existing multi-track deck. After all, there's something to be said about having two machines that can be used separately when needed. The NCRE will

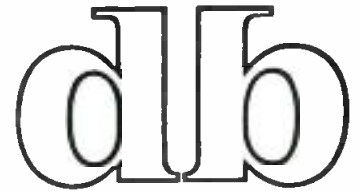

THE SOUND ENGINEERING MAGAZINE

## SALES OFFICES

**New York**  
980 Old Country Road  
Plainview, N.Y. 11803  
516-433-6530

**Dallas**  
Roy McDonald Associates, Inc.  
Stemmons Tower West  
Suite 714  
Dallas, Texas 75207  
214-637-2444

**Denver**  
Roy McDonald Associates, Inc.  
3540 South Poplar Street  
Denver, Colorado 80237  
303-758-3325

**Houston**  
Roy McDonald Associates, Inc.  
3130 Southwest Freeway  
Houston, Texas 77006  
713-529-6711

**Los Angeles**  
Roy McDonald Associates, Inc.  
500 S. Virgil  
Suite 360  
Los Angeles, California 90020  
213-483-1304

**Portland**  
Roy McDonald Associates, Inc.  
2035 S. W. 58th Avenue  
Portland, Oregon 97221  
503-292-8521

**San Francisco**  
Roy McDonald Associates, Inc.  
Baybridge Office Plaza, Suite 265  
5801 Christie Avenue  
Emeryville, California 94608  
415-653-2122

## advertisers index

Beyer-ReVox . . .	facing Cover 2
Beyer-Gotham . . .	10
Bose . . .	10
CBS Labs . . .	6
EMT . . .	Cover 2
Electro-Voice . . .	Cover 4
Elpa-Ferrograph . . .	6
Fluke . . .	27
Gately . . .	15, 17
Gotham . . .	Cover 2, 10
Lang . . .	12
Maxell . . .	3
Multi-Track . . .	13
Pacific Recorders . . .	13
Pentagon . . .	9
Perception . . .	12
Ramko Research . . .	8
Rectilinear . . .	7
Shoeps . . .	15
Shure . . .	5
Tascam . . .	4
Timekeeper . . .	11, Cover 3

# We offer you better quality masters, but you'll have to work for them.

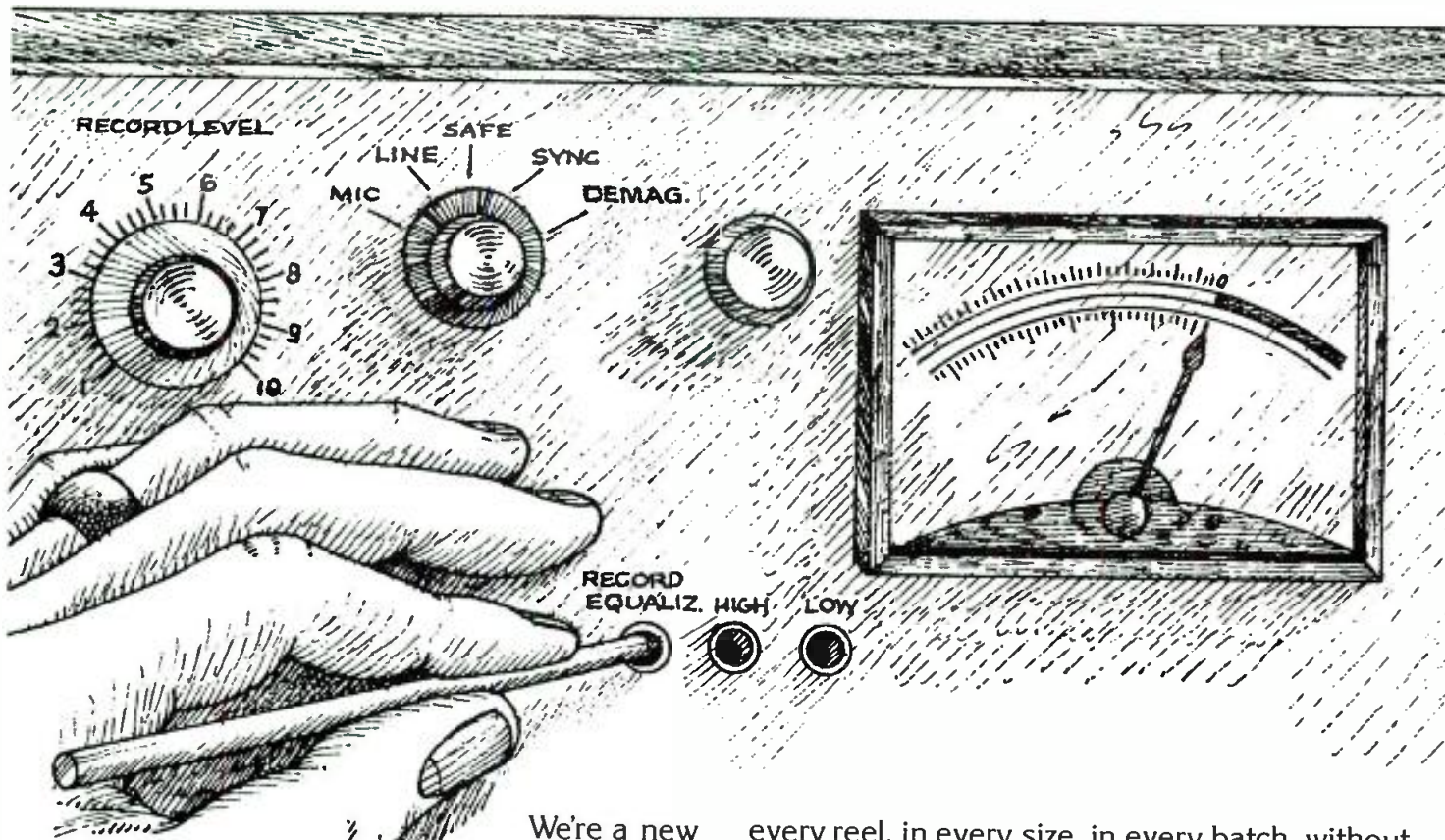

We're a new mastering tape formulation, so the limits of older tapes don't apply to us. Initially, our extra quality needs some getting used to. To upgrade your original recordings, you'll have to adjust your equalization and bias controls to our specifications. That's not much work, but it's necessary. And it's worth it.

When you play back your first reel of Maxell mastering tape you'll notice how clean it works. Our tape doesn't use a carbon backing so there's no messy carbon shedding. Sheddings cause noise, thumping and interference. On the reel, carbon can also transfer to the recording surface and cause dropouts.

Because of the care we take in the manufacturing process, you won't find any pinholes in our oxide coating. No pinholes and no shedding mean Maxell mastering tape is virtually 100% free from dropouts.

And you get Maxell's low noise level, wide range and freedom from distortion with

every reel, in every size, in every batch, without fail. That's a statement about quality performance you won't find other manufacturers making anymore. We're eager to draw your attention to the edge-to-edge, end-to-end quality you'll find in Maxell mastering tape.

Send in the coupon for documented evidence about Maxell tape performance. Then think about the repeat sessions Maxell quality will eliminate. That's a lot of work you won't have to do.

Send to: Maxell Corporation of America  
130 West Commercial Avenue  
Moonachie, N.J. 07074      Dept. 6DM

Gentlemen:  
Send me technical information and tell me how I can get Maxell mastering tape.

name/title \_\_\_\_\_

company \_\_\_\_\_

address \_\_\_\_\_

city \_\_\_\_\_ state \_\_\_\_\_ zip \_\_\_\_\_

**maxell.**

The answer to all your tape needs.



# TEST TAPES

Available in cassette or open reel, each precision calibration and alignment tape is individually mastered from the finest instrumentation by the Standards Laboratory of TEAC Audio Systems Corporation of Japan.

To avoid undue aging, the tapes are normally produced to order and are shipped in a shielded metal canister.

Each tape is individually serialized and includes specific tolerances where applicable.

Test tapes are available for speed deviation checks, standard operating levels, azimuth standards, frequency alignment standards and references, standard reference level, and cross-talk checks.

Tapes made to custom requirements will be quoted on request.

*TEAC Calibration & Alignment Tapes are exclusively distributed in the U.S. and Canada by*

 **TASCAM CORPORATION**  
5440 McConnell Avenue  
Los Angeles, Calif. 90066  
(213) 390-3566

poll its members to see what the consensus is on the various ways to go beyond 16 tracks. Then, it will inform the membership of the results of the survey, and in addition make a general statement to the industry based on this information.

NCRE representatives are; Larry Levine—A&M Records, Los Angeles, Glenn Snoddy—Woodland Sound, Nashville, Phil Ramone—A&R Recording Studios, New York, and, me. For the moment, the NCRE will operate out of my New York City office.

The annual membership fee is \$25.00. Checks may be made out to the National Council of Recording Engineers, and mailed to N. C. R. E. 64 University Place, New York, N. Y. 10003. Or, phone me at 212 673-9110 for more information. Members will receive a detailed questionnaire to be filled out and returned. This information thus gathered will form the basis of the NCRE's first report to its members.

## THE FORTY-FIFTH A.E.S. CONVENTION

As this is being written, the 45th A.E.S. Convention is just over. As always, the exhibits were well received by the many convention visitors. At least a few appreciative comments were heard—from easterners, no doubt—about the relaxed, informal atmosphere.

Now that Europe has proven a successful convention site (did anyone need to be told?), I wonder if we might have the European meeting in May or June, with the California show during the winter. That way, overseas vacation plans might be scheduled around the European meeting, and likewise, southern California might attract out-of-towners during the winter months. As for New York, any suggestions?

Of course, there was a quad session at L. A. (although there won't be one in New York this fall). John Eargle took us "Beyond Quad" (AES Preprint L-2), and Jim Cunningham discussed "Reverberation requirements for Quad Studio Recording" (L-3). As impressive as these papers were, I must immodestly draw attention to my own contribution to the literature.

Just before leaving for California, my house burned down. With it went the manuscript to my own quad paper. This may be the first time in the history of the A.E.S. that an author had the presence of mind to burn his paper *before* reading it. Shouldn't there be some sort of award for this sort of consideration?

Another casualty was Al Grundy's paper. Since he and I were—sort of—co-authors, his contribution went up in smoke along with mine, for at the time of the blaze I was collating our little opus. However, he quickly improvised a new presentation, drawing in part on an earlier paper he gave in New York. In brief, he attempted to explain the mathematics of the matrix, and I have asked him to expand his notes into a feature article for *db*. It's about time somebody explained what all those cosines of theta are about.

Developments in digital techniques continue. Richard Factor of Eventide Clockworks described his "Continuously Variable Digital Audio Delay Line" (E-1). The continuously variable function greatly expands the special effects capabilities of this device, and makes it an even more useful studio tool.

This convention saw the largest number of exhibitors in the society's history. And speaking of history, Jack Mullin's Museum of early recording instruments was surely the highlight of the show. I'm told that arrangements are under way to bring the museum to New York for the fall

---

## you write it

Many readers do not realize that they can also be writers for *db*. We are always seeking good, meaningful articles of any length. The subject matter can cover almost anything of interest and value to audio professionals.

Are you doing something original or unusual in your work? Your fellow audio pros might want to know about it.

You don't have to be an experienced writer to be published. But you do need the ability to express your idea fully, with adequate detail and information. Our editors will polish the story for you. We suggest you first submit an outline so that we can work with you in the development of the article.

You also don't have to be an artist, we'll re-do all drawings. This means we do need sufficient detail in your rough drawing or schematic so that our artists will understand what you want.

It can be prestigious to be published and it can be profitable too. All articles accepted for publication are purchased. You won't retire on our scale, but it can make a nice extra sum for that special occasion.



Modular sound control center I.\*

**Mix. shape. add reverb for \$223.**

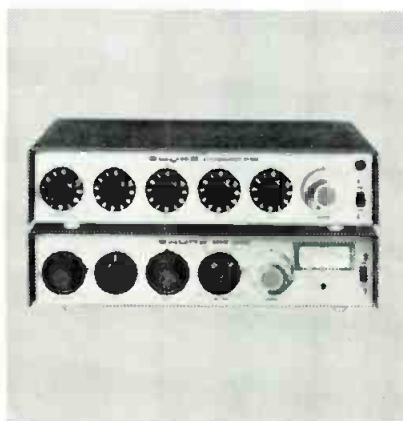

Shure supplies the ingenuity and the components—but you take the credit for one of the most clever, most economical sound reinforcement “consoles” ever devised! Here’s how: Install a Shure M68RM mixer, stacked with a Shure M63 Audio Master. The M68RM handles the input of up to four microphones, accepts a separate high level signal (such as a tape recorder or tuner signal), and has variable-intensity reverberation capability. The ingenious M63 gives you high and low frequency filters with separate bass and treble controls, so output signals can be tuned to a wide variety of response characteristics to suit program material to room acoustics—providing low-cost room/system equalization and better feedback control. It delivers precisely the audio control needed—no more, no less. And it’s expandable for future needs. Great idea, great components, great price!

\*More to come . . . other ingenious sound control centers will be discussed.

Shure Brothers Inc.  
222 Hartrey Ave., Evanston, Illinois 60204  
In Canada: A. C. Simmonds & Sons Ltd.



Circle 18 on Reader Service Card

[www.americanradiohistory.com](http://www.americanradiohistory.com)

Send only  
the best.

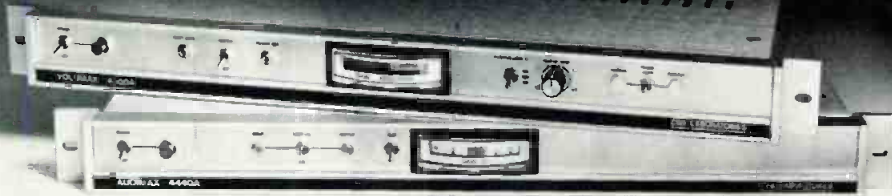

Only the best is good enough. And that's exactly what you get with CBS Laboratories power twins, Audimax and Volumax. Audimax delivers a distortion free signal by eliminating thumping, background "swish-up" and audio "holes." And Volumax prevents overmodulation and permits maximum per-watt coverage power. The power twins! From CBS Laboratories, of course.

## CBS LABORATORIES

A Division of Columbia Broadcasting System, Inc.  
227 High Ridge Road, Stamford, Connecticut 06905

Circle 14 on Reader Service Card

# All New and Improved Ferrograph RTS-2

### Simple to operate

- Learn to use in minutes
- Minimum set up time
- Only two leads necessary
- Pushbutton activation

### Versatile all-in-one precision test unit

- Sine Wave generator
- Millivoltmeter
- Wow & Flutter bridge with expanded range
- Harmonic distortion analyzer with greatly simplified measurements

### Use it anywhere

- Recording & broadcasting studios
- Testing laboratories
- Service Shops
- Compact, lightweight, portable

All this for only \$1450

- Sturdy carrying case optional

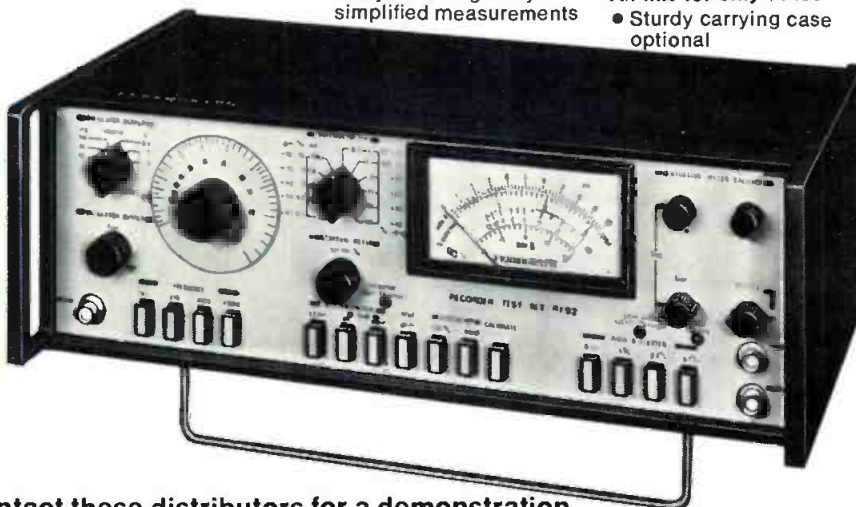

### Contact these distributors for a demonstration.

Birmingham, Ala. Maze Corp. 1900 1st Ave. North	Mountain View, Calif. Scully/Metroteck 475 Ellis St.	Ft. Lauderdale, Fla. Broadcast Automation Assocs. 3101 N. Federal H'way Chicago, Ill. B. W. Assocs. 415 W. Fullerton P'kway	Grand Rapids, Mich. Audio Distributors 2342 Division Ave., So.	Hendersonville, Tenn. Studio Supply Co. 112 Cloverdale Court
Los Angeles, Calif. Westlake Audio 6311 Wilshire Blvd.	Stamford, Conn. Audio Techniques 121 Hamilton Ave.	New York, N.Y. Harvey Radio 444 Madison Ave. Martin Audio 320 W. 46th St.	Dallas, Texas 75240 Mill-Tronics, Inc. 4304 Bellwood Pkwy No.	

Circle 11 on Reader Service Card

convention. Don't miss this interesting display.

At the Audio Techniques/Audio Europe booth, Larry Scully was on hand to show his new Preview Master ¼-inch tape deck. The machine has an ingenious variable distance device for adjusting the advance time of the preview head for tape-to-disc work. Larry's Preview Master should not be confused with the Scully/Metrotech line, which is a completely different company now.

Also seen at the Audio Techniques booth were the Keith Monks microphone stands and a few Triad console modules, both from Great Britain. A complete Triad console is expected for the New York show.

The Xedit booth attracted a lot of attention throughout the week. Their multitrack playback machine is beautifully constructed and should be a welcome addition in any mixdown room, especially considering its modest price tag (\$5,800 for the 16-track version, with a real time counter).

At Audio Designs, Bob Blum's exhibit featured the 560 VueScan. This device displays up to 28 channels of level indicators in a bargraph format on a 12-inch or 16-inch monitor.

Tragedy struck the exhibit area late one afternoon when Allison Research ran out of iced apple juice. A panic was narrowly averted when someone pointed out that the Hilton bar would remain open during the crisis period. ■

## Copies of db on Microfilm

Copies of all issues of db—The Sound Engineering Magazine starting with the November 1967 issue are now available on 35 mm. microfilm. For further information or to place your order please write directly to:

University Microfilm, Inc.  
300 North Zeeb Road  
Ann Arbor, Michigan 48106  
A subsidiary of Xerox Corporation

In addition to Microfilm Copies available through University Microfilm, we have a limited number of regular back issues available. You may order these copies at \$1.00 each from:

Circulation Department  
db—The Sound Engineering Magazine  
980 Old Country Road  
Plainview, New York 11803



# After the monthly breakthroughs and revolutions in speaker design, how come the Rectilinear III still sounds better?

Figure it out for yourself.

More than five years ago, without much fanfare, we came out with a very carefully engineered but basically quite straightforward floor-standing speaker system. It consisted of six cone speakers and a crossover network in a tuned enclosure; its dimensions were 35" by 18" by 12" deep; its oiled walnut cabinet was handsome but quite simple.

That was the original **Rectilinear III**, which we are still selling, to this day, for \$279.

Within a year, virtually every hi-fi editor and equipment re-

viewer went on record to the effect that the **Rectilinear III** was unsurpassed by any other speaker system, regardless of type, size or price. (Reprints still available.)

Then came about forty-seven different breakthroughs and revolutions in the course of the years, while we kept the **Rectilinear III** unchanged. We thought it sounded a lot more natural than the breakthrough stuff, but of course we were prejudiced.

Finally, last year, we started to make a **lowboy** version of the **Rectilinear III**. It was purely a cosmetic change, since the two versions are electrically and acoustically identical. But the

new **lowboy** is wider, lower and more sumptuous, with a very impressive fretwork grille. It measures 28" by 22" by 12 1/4" deep (same internal volume) and is priced \$20 higher at \$299.

The new version gave *Stereo Review* the opportunity to test the **Rectilinear III** again after a lapse of almost five years. And, lo and behold, the test report said that both the original and the **lowboy** version "are among the best-sounding and most 'natural' speakers we have heard." (Reprints on request.)

So, what we would like you to figure out is this:

What was the real breakthrough and who made it?

For more information, including detailed literature see your audio dealer or write to Rectilinear Research Corp., 107 Bruckner Blvd., Bronx, N. Y. 10454.

**Rectilinear® III**  
*Engineering Excellence*



Circle 27 on Reader Service Card  
[www.americanradiohistory.com](http://www.americanradiohistory.com)



# Foot loose

'n fancy free. That's us.



Beautiful schooner.  
Exciting li'l West Indies Isles.  
And you.

If you're congenial and  
would like to sail with a  
small, intimate group,  
we're for you and you're  
for us. Now forming to sail.

Your share from \$245.  
10 great days. Hurry.

Write today for information.



Name \_\_\_\_\_  
Address \_\_\_\_\_  
City \_\_\_\_\_ State \_\_\_\_\_ Zip \_\_\_\_\_  
Phone \_\_\_\_\_

P.O. Box 120, Dept. 970D, Miami Beach, Florida 33139

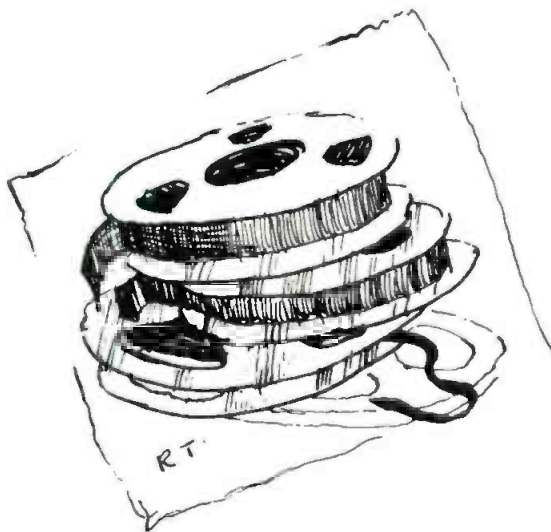

## The duplicator that runs ahead of competition...

This one stands alone.

PRO-Series 2800 high speed EIGHT-TRACK  
tape duplicating systems by Pentagon.

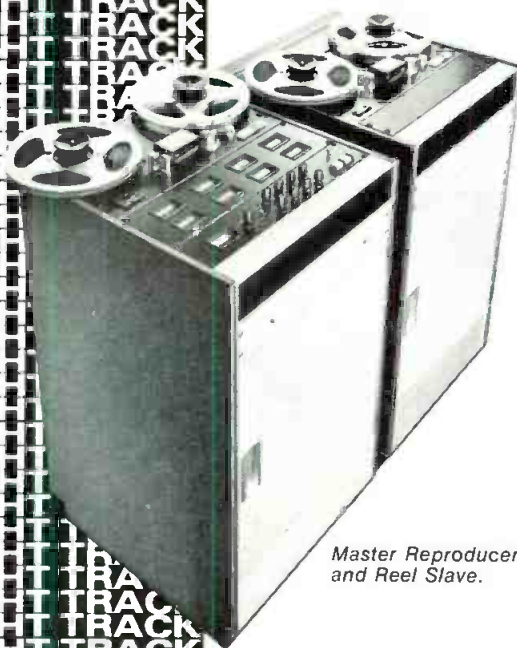

Master Reproducer  
and Reel Slave.

The only professional 8-track duplicating systems built in America at a surprisingly modest price. The only one.

Here is a duplicator system unique unto itself. It has a superb combination of features.

- Broadcast quality of duplicates
- Completely solid state
- Virtually maintenance free
- Full control facilities
- Excellent frequency response
- Fully automated operation for reel to reel duplication
- Modular plug-in solid state electronics

And what flexibility. Reel to open reel; Reel to direct cartridge hub (eliminates loading procedure); choice of 1/4 inch or 1 inch reel masters; automatic rewind and restart of your reel master, just to name a few.

Recognized as the leader in the manufacture of professional high speed in-cassette and open reel tape duplicators, Pentagon's entry into the 8-track duplicating equipment field fulfills a long awaited need for a truly versatile and professional system.

Write or call Pentagon direct for full information on the PRO-Series 2800 line of 8-track duplicating systems. You'll be glad you did.

**Pentagon**  
Industries, Inc.

4751 N. Olcott Ave.  
Chicago, Illinois 60656  
(312) 867-9200

Creators of quality in cassette duplicators

# ONE OF A KIND



ACTUAL SIZE

Why do so many manufacturers turn to Beyer for their input transformers?

Even though they could get them from the people who supply their power transformers?

Because *this* one has a unique winding process that permits miniaturization while maintaining studio quality frequency response, low distortion, and level capability—at reasonable cost.

Because *this* one represents 40 years of quality manufacturing experience.

Who are the manufacturers we're talking about? The leaders. Including Ampex, Ampro, Barcus-Berry, Bell P.A., Bozak, Electro-Sound, Rauland-Borg, RCA, 3M, and many others.

You can obtain Beyer transformers at retail through Gotham's franchised dealer organization. Or in OEM quantities directly from Gotham. Write today:

**GOTHAM**  
AUDIO CORPORATION

Headquarters: 741 Washington St.  
New York, NY 10014 Tel: (212) 741-7411

## HOW GOOD SHOULD A REINFORCEMENT SYSTEM SOUND? SO GOOD YOU DON'T HEAR IT!



Listen to the remarkable **BOSE 800™**

Portable Loudspeaker System and all you'll hear is the performance, without artificial coloration. After all, isn't the performance really what the audience comes to hear?

**Bose 800, The Unobtrusive One**

Please send complete information to:

Name \_\_\_\_\_  
Address \_\_\_\_\_  
City \_\_\_\_\_ State \_\_\_\_\_ Zip \_\_\_\_\_

Return to Bose Corp.  
The Mountain  
Framingham, Mass. 01701  
Dept. BD

Circle 20 on Reader Service Card

Figure 2: These sketches show how to obtain a correctly designed electronic crossover with 24 dB/octave ultimate slope and a 12 dB/octave slope at the crossover frequency. Top, the block schematic; bottom, how the response is built up. Curves 1, the response of each roll-off within the feedback loop; curves 2, the combined response within the feedback loop; curves 3, the response external to the feedback loop before adding the external roll-offs; curves 4, the response of each external roll-off; curves 5, the combined response to the two external roll-offs; curves 6, the final response from input to the respective outputs. Notice that the triangles in the upper part of the figure represent isolation between roll-off effects, with or without amplification.

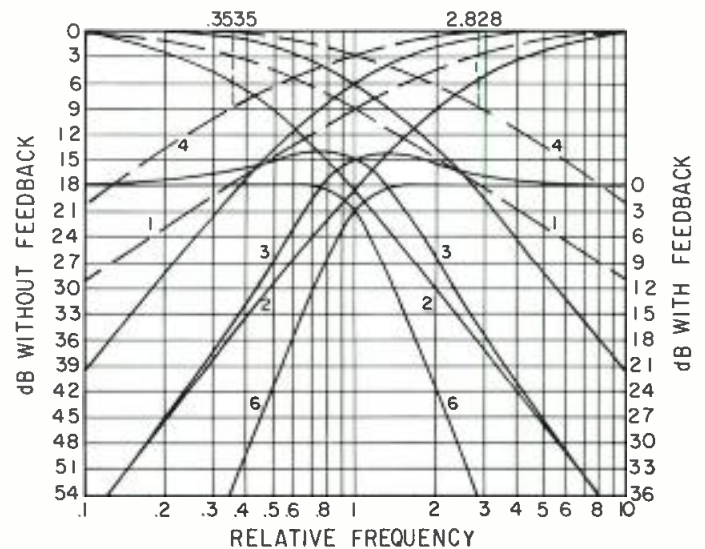
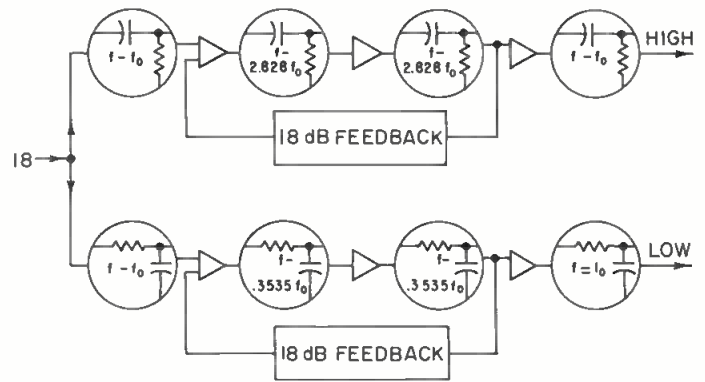

help. That, I suppose, is a sort of apology.

I mention that, because the query I want to deal with here results from such an occurrence. In my *Audio Systems Handbook* appears the schematic shown at FIGURE 1, for a 24 dB/octave electronic crossover network. Further over, the operation of the same network is explained with FIGURE 2. But the book does not really tell the reader how to align such a network. And I know I left that out because I had done it before. So this reader wrote to ask how he could change the circuit for single-ended (unbalanced) input, and to work at 800 Hz, instead of 1000 Hz.

The first part is easy. Just eliminate the 330 ohm resistor between the lower input terminal and ground. If necessary, change the input values to suit the desired input impedance, which would then be about 300 ohms.

The second part is also easy, in theory at least. Just multiply all the frequency selective capacitors by 1.25, because the frequency is reduced by 4/5, from 1000 to 800 Hz. The capacitors affected are those shown as

0.5 (4 of) 0.01, 0.0075, 0.1 (2 of), 0.4 and 0.33. If you could just put together the components shown in FIGURE 1, and you'd have a 1000 Hz crossover, you could just substitute values of 1.25 each of these components, and you'd have an 800 Hz crossover.

The point is that neither of these operations is quite that easy in practice, which is why I showed the principle on which the network is built in FIGURE 2. To get it working as it should, you need to make sure that the components actually do what FIGURE 2 specifies. Otherwise, cumulative errors in values with 10 per cent and 20 per cent tolerances can make the overall result show considerable deviation from the expected response because of its relatively critical shaping.

But what the book did not show was the easiest way to do this, which is using an oscilloscope connected so input goes to the horizontal deflection and output to the vertical. Let us run through this to see what I mean. You start with the roll-offs within the feedback loops. To do this, disconnect the resistors shown in FIGURE 1 as 56 k,

and use a value of about 100 k from supply + to that first transistor base, checking that satisfactory amplifier operation is achieved.

You connect the input from the oscillator, first to the horizontal deflection of your oscilloscope, then through at least 10 k, better 33 k or 100 k, to the base of the input transistor of the network you are going to align. For the HF section, take the output to the vertical scope deflection from the third transistor collector, and bypass, first one coupling capacitor, then the other, with, say, a one mF capacitor, to eliminate that roll-off.

You then adjust the value on the other coupling capacitor to get the correct roll-off at 2.828 times the crossover frequency. If you want crossover at 800 Hz, the frequency to use here would be 2,260 Hz. At that frequency, when you have the correct coupling capacitor, you should get the trace shown at FIGURE 3(A). First set the trace at some frequency well above 2,260 Hz—preferably above 10,000 Hz, to the 45 degree line, measuring, say, 10 cm each way. Then set frequency at 2,260 Hz, when the trace should be that of the ellipse, which represents 3 dB loss with 45 degree phase shift.

You change the capacitor value

until it is so. Then you bypass that coupling capacitor and adjust the other one in the same way. Now remove the bypass altogether, and the trace should be as at FIGURE 3(B), which represents 6 dB loss with 90 degree phase shift, again at 2,260 Hz, after adjusting for the 45 degree line at a much higher frequency.

Now you have to apply the correct feedback, by changing the bias on the input stage from the 100 k resistor temporarily connected from supply + to first transistor base, to the one shown as 56 k. When you make this change, gain should drop, at a frequency of say 10,000 Hz, by a factor of 8:1, to represent 18 dB feedback. That is a first check. But more importantly, when you set the trace for a 45 degree line again at this high frequency, and now check response at your crossover frequency, 800 Hz, it should be that shown at FIGURE 3(C), an ellipse of 1.414 times as high as the line, representing +3 dB with 90 degree phase shift.

Adjust the feedback so you get this. You may need to change some other values in circuit, to keep correct operating point for the first transistor, and perhaps check back that your internal roll-offs are correct.

Finally, you check your input and

John M. Woram announces the formation of:

## WORAM AUDIO ASSOCIATES

64 University Place  
New York, N.Y. 10003  
212 673-9110

45 Lakeside Drive  
Rockville Centre, N.Y. 11570  
516 OR 8-1270

— offering —

- A Complete Consultation Service for Studio Planning and Construction
- Free-Lance Recording Service at Selected New York Studios
- Emergency & Preventive Maintenance of Studio Equipment in New York City Area

## Best-selling accessories for recording studios and broadcasting stations

Model T-1 Electronic



### STOP CLOCK

A digital instrument that is the modern version of the traditional stop watch. It does everything a stop watch does except that the results appear on an easily read visual display.

Features:

- Remote operation if desired
  - 120 volt 50 or 60 Hz.
  - Panel mounting possible
  - Provisions for slave units
  - High degree of accuracy
  - Highest quality design and construction
  - One year guarantee
  - A "delight" to use
- Only \$185.00



Standard Model

### TAPE TIMER

The most popular Tape Timer in the field.

Features:

- Calibrated for 7.5 and 3.75 ips but can also be used at 15 ips
  - Easily mounted on any 1/4 inch recorder
  - Moves in unison with tape so that fast forward or reverse moves the pointer correspondingly
  - You can stop, rewind, fast forward or play tape continuously and repeatedly without deranging the timing
  - A "must" for editing
- Only \$59.95

New York State residents add 7% sales tax.

Send check to

## TIMEKEEPER

P.O. Box 835 Great Neck, N.Y. 11021

A recording engineer relies upon his ears. What is heard at the console determines the final mix.

For successful quadraphonic mixdown, a properly controlled acoustical environment is even more important than for two-channel stereo. Psycho-acoustic effects must be considered in relation to established principles of acoustics when laying out a quadraphonic monitoring facility.

A professional consultant experienced in designing control rooms for quad monitoring can be of great help. He is impartial because he sells no equipment. His function is to assist in solving acoustical problems. Best of all, if called in the planning stage, he can solve potential problems before they exist.



Circle 19 on Reader Service Card

#1 in the field for Performance & Reliability!



## LANG SOLID STATE PROGRAM EQUALIZER

Unsurpassed in design, performance and versatility, the LANG SOLID STATE PROGRAM EQUALIZER has been the leader for over 6 solid years incorporating the finest features...

### PLUS THESE EXCLUSIVE FEATURES —

- Eight low boost shelf frequencies • Four low droop shelf frequencies • Eight high boost peak frequencies • Six high droop shelf frequencies • Frequency select switches and equalization controls for all boost and droop functions • All controls and switches may be used simultaneously • Low frequency peak boost by use of boost and droop controls • Equalization "on" lamp indicates when equalization is taking place • Stainless steel panel blends harmoniously with other equipment • Plug-in printed circuit amplifier and power supply cards • Compact size: 3½" x 19" •

For Complete details and new Lang Catalog write:

**LANG ELECTRONICS INC.**  
14 East 39th St., N.Y. 10018  
For all your audio needs look to Lang!

Circle 17 on Reader Service Card

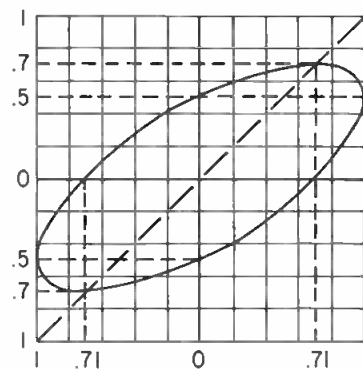

(A)

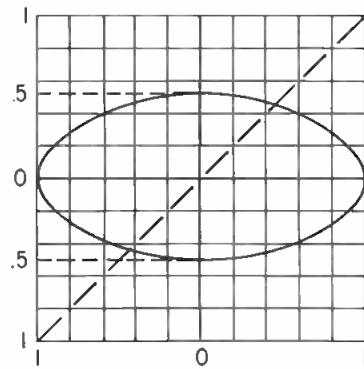

(B)

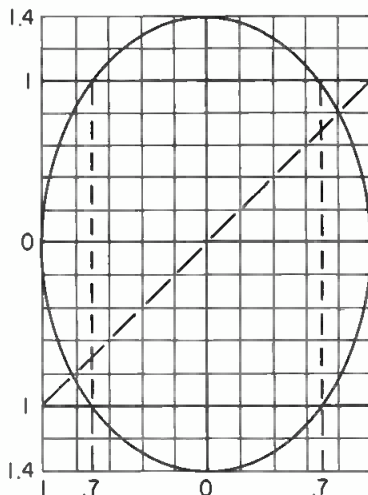

(C)

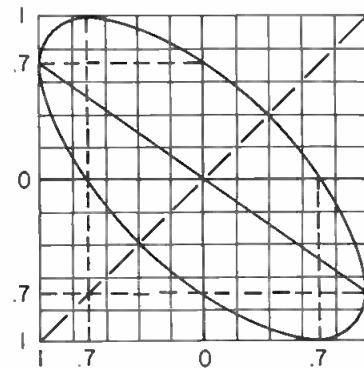

(D)

Figure 3: Oscilloscope traces to help in the alignment of 24 dB/octave crossover networks: (a) for the 3 dB, 45-degree point in a single roll-off; (b) for two roll-offs combined, within a feedback loop, before the feedback is applied; (c) for the same two roll-offs, after the correct amount of feedback has been applied. (Note: the ellipses in (b) and (c) are obtained at different frequencies, see text.) (d) shows the final steps of alignment.

output roll-offs. To do this, you connect your input to the input terminals, and your output to the junction of the values shown as 0.5 and 330 (you may have already made substitutions here). Adjust these till you get the trace of FIGURE 3(A) at crossover, 800 Hz, after setting the 45 degree line at a higher frequency.

At the output end, feed the input through, say, 100 k to the base of the third transistor, and measure output at each output terminal. This, too, should give a trace like FIGURE 3(A), after the same adjustment. Now, if you connect your input (without series resistor) to the network input, the trace you get at crossover, after adjusting for the 45 degree trace at some higher frequency, should be the ellipse of FIGURE 3(D) at collector of the third transistor, and the oppositely sloping line at the output, representing 3 dB loss with 180 degree phase shift.

The LF section is a little easier to check. To remove the roll-offs, instead of using bypass capacitor(s), as for the HF section, you just remove the roll-off capacitors. Thus, to align the internal roll-offs, you remove both the values shown as 0.4 and 0.33, and apply them separately, one at a time. Each should produce the trace shown at FIGURE 3(A), at a frequency of 0.3535 times crossover, which for 800 Hz, will be 283 Hz. This is done after setting up the 45 degree line at a much lower frequency, say 50 Hz.

When both these capacitors are connected, your internal response, without feedback, should be as at FIGURE 3(B), using the same frequency, 283 Hz. Now apply and adjust feedback, to get the response of FIGURE 3(C) at crossover, 800 Hz, and finally add the end roll-offs, shown here as using 0.5 capacitors to get the responses of FIGURE 3(D).

Once you get the hang of it, this is

a pretty good marriage of theory and practice. Trying to verify the responses of FIGURE 2 could take an age between making needed changes. But using this kind of trace makes it much easier to do. You find you are "off" by some factor. Say, the correct trace appears at 1950 Hz instead of 2260 Hz. This means the relevant capacitor is too big. Setting the slide rule to 2260 and 1950 align on the C and D scales, you find that the required capacitor is 0.865 times the value you have, which you can then adjust on your capacitor checker.

With practice, you come to the quickest way to make changes that move quite directly to a proper alignment of the circuit for correct overall performance.

This column may sometimes seem to switch subject matter, between technical matters such as the one we have just gone through, and various aspects of education. But really these subjects are very closely intertwined. The books give the theory, and the engineer, technician, or whomever you are, is expected to know how to apply that theory in practice.

Practical, how-to-do-it books, too often merely tell you, in Step 1, 2, 3 . . . form, how to do the job. In this instance, it would say, "Step 1, connect your oscillator to your oscilloscope [spelling out all the details] and to such and such points in your network." "Step 2, with frequency set at . . . adjust the oscilloscope so and so." "Step 3, with frequency set at . . . change the value of the capacitor at a specified circuit location, until the response is as at . . ." And so forth through what would probably be more than 100 steps.

The practical man can only follow such instructions, step by step, because he does not really know what each step does. And if he wants to align a circuit that is a little different—say 18 dB/octave instead of 24—he must go out and get another book, if there even is one.

My point is that most books fail to bridge the gap between theory and practice, and education, both non-technical and technical, is usually of little help in preparation. Many people see this, but doing something about it is another matter. Government programs, such as the one I mentioned a while ago, get diverted by all kinds of bureaucratic interferences, and I have just signed a contract to produce materials on electronics for a private organization called Educational Research Associates, based in Portland, Oregon. Their concern is to produce something that will sell because it is good and does what it sets out to do. It can't afford

61036 → IPS

THE MDA-1B IS A SELF-CONTAINED RACK MOUNT, OR TABLE TOP UNIT, INTENDED TO SUPPLY DRIVE MOTOR POWER TO PROFESSIONAL TAPE DECKS FOR THE PURPOSE OF VARYING TAPE SPEED UNDER PRECISE CONTROL.

**\$695**

## MULTISYNC MDA-1B

**FEATURES:**

- \* WIDE FREQUENCY RANGE 48 - 144 Hz
- \* VERNIER CONTROL FOR FINE PITCH ADJUSTMENT
- \* NO MODIFICATIONS OF RECORDER REQUIRED
- \* FIXED 120 HZ. FOR 30 IPS OPERATION
- \* FAIL-SAFE AMPLIFIER PROTECTION CIRCUITRY
- \* EASILY PATCHED FROM RECORDER TO RECORDER
- \* QUADRATURE DRIVE FROM DUAL AMPLIFIERS AND 90 DEGREE OSCILLATORS

**APPLICATIONS:**

- \* "PHASING-DELAY" EFFECTS
- \* TUNE TRACKS FOR RECORDING NON-TUNEABLE INSTRUMENTS
- \* 30 IPS DRIVE FOR 7.5/15 IPS RECORDERS
- \* COMPENSATE FOR OFF-SPEED TAPES
- \* VARIABLE-DELAY FOR DOUBLE-TRACKING
- \* LENGTHEN/SHORTEN RUNNING TIME OF BROADCAST TAPES

THE MDA-1B CONTAINS ITS OWN POWER SUPPLIES, OSCILLATORS, AND POWER AMPLIFIERS. THE CONNECTIONS TO AND FROM A DECK ARE MADE BY TWO CONTROL CABLES. THESE CAN BE INSERTED INTO EXISTING CONNECTORS WITHOUT ANY MODIFICATION TO THE TAPE DECK.

**PACIFIC RECORDERS AND ENGINEERING CORPORATION**  
 11760 SOPRENTO VALLEY RD., SAN DIEGO, CALIFORNIA 92121  
 TELEPHONE (714) 453-3255

Circle 23 on Reader Service Card

to be bound up with some of the folly present in our educational system, about which I have talked in earlier issues. Although some professionals at first hesitated to use the "commercial" materials produced by this organization, their value is beginning to be recognized. Educational Research has already supplied materials to more than two thousand schools across the country; they pass the word, re-order, expand into other products because the ones they have got prove their worth, and so forth.

So it begins to look as if "doing it right" will win out after all. The atmosphere in Washington seems hopeful too, at this stage. I am told that legislation is being drawn up to remove the fragmentation that federal funding has engendered; this should enable products to be judged by their performance instead of by whether they are produced by a group arbitrarily designated as "professional" because the people in it have the "inside track" in the U.S. Office of Education! ■

Presenting The

## VARI-BAND SWEEP EQUALIZER!

Equalization any way the ear can hear it.

Continuously variable bandcenter, bandwidth (slope) and amplitude at a price comparable to non-sweeping equalizers.

## MULTI-TRACK

P. O. Box 3187, Hollywood, CA 90028  
 1965 Cheremoya Ave., Hollywood, CA 90068  
 (213) 467-7890

Circle 21 on Reader Service Card

# NEW PRODUCTS AND SERVICES

## BROADCAST AUDIO-MIXER

● Studio/master 505 features integrated circuitry throughout. Features include: five miking channels, four channels with built-in preamps, each channel adjustable for mic, phono or hi-level. Channel 5 has five hi-level balanced inputs with push-button key switching. Built-in 25 watt monitor amp, built-in cue speaker, built-in headphone amp for headset, fet monitor muting and long-life led indicators. Cues on any channel, and uses Allen-Bradley MOD POTS. Rack mounted in a 5¼ inch space; also available in a cabinet. Maroon anodized aluminum faceplate, blue-grey cabinet.

*Mfr: Russco Electronics*

*Price: Under \$500 for rack mounted model*

*Circle 54 on Reader Service Card.*



## EXPANDABLE KEYBOARD SYNTHESIZER

● Full patch panel for inexpensive expansions with the addition of the ElectroComp 200 Studio Synthesizer is offered with ElectroComp 101 synthesizer. This portable unit provides a two-voice polyphonic keyboard, four voltage controlled audio oscillators, a voltage controlled filter, voltage controlled amplifier, two envelope generators, white noise source, microphone amplifier, sample and hold, ring modulator and mixers.

*Mfr: Electronic Music Laboratories, Inc.*

*Price: \$1,295*

*Circle 59 on Reader Service Card.*



## FOUR-CHANNEL HEADPHONES

● Dynaphase Sixty Five Four C headphones are designed for reception of both discrete and matrix derived compatible systems; can be converted to conventional stereo with the flip of a switch. There are two speakers in each earpiece, marked for left and right and containing two plugs, blue for front and black for rear speakers. Frequency response is 20-20,000 Hz; 100 dB sound pressure level is at 0.10 volts, input at one kHz for each channel; distortion less than ½ per cent at 110 dB sound pressure level. Equipped with headband and ear cushions. Complete with eleven-foot coiled cord and switch.

*Mfr: Stanton Magnetics, Inc.*

*Price: \$64.95*

*Circle 84 on Reader Service Card.*



## VOLTAGE-CONTROLLED AMPLIFIER



● An accurate voltage-controlled gain without audibly degrading the controlled signals in any way is provided by model 169A. According to the manufacturer, its total harmonic distortion is typically rated at 0.05 per cent and its typical overload-to-noise ratio is 92 dB; it can provide up to 25 dB gain. There are pre-drilled holes for two resistors which can be added to adjust the gain for specific requirements. In addition to four independent control voltage inputs, a current input is also provided to permit the addition of additional voltage inputs by adding resistors. Although the normal gain reduction is ten times the sum of all control voltages, this relationship can be changed; pre-drilled holes and traces permit the installation of an RC pre-emphasis network. Optional features include a bipolar  $\pm$  volt supply, regulated to  $\pm 0.1$  per cent and a rack which can house up to twelve 169A modules.

*Mfr: Parasound*

*Price: \$59.00 (Quantities of 100.)*

*Circle 74 on Reader Service Card.*

## REEL-TO-REEL RECORDER/REPRODUCER

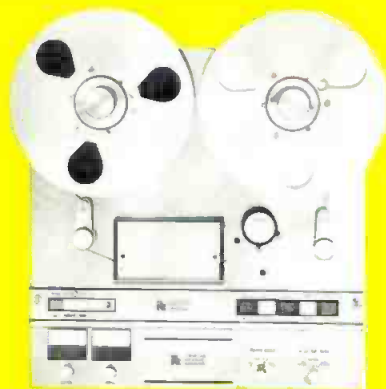

● The three-motor design of this reel-to-reel recorder/reproducer includes direct capstan drive, single or dual speed, motion sensing, edit mode, play/record synchronization, and i.c. logic. Available in 10½ and 14 inch reel capacities.

*Mfr: International Tapetronics Corp.*  
*Circle 66 on Reader Service Card.*



## ALIGNMENT TAPE



● Alignment tape, AT-120, designed for all 1/4-inch reel-to-reel recorder players is a professional quality 7.5 in./sec., full-track master recording with equalization and levels in accordance with NAB standards. Frequency response tones recorded include: 400 Hz., -10 dB frequency response calibration; 5 kHz., -10 dB; 1 kHz., calibration; 5kHz., -10 dB coarse azimuth; 15 kHz., -10 dB fine azimuth; 10 kHz., -10 dB; 1 kHz., -10 dB; 100 Hz., -10 dB. Tones also include: 400 Hz., 0 dB NAB standard reference level; 100-10,000 Hz., sweep frequency; 3kHz., 0 dB wow and flutter, two minutes.

Mfr: Nortronics Co. Inc.

Circle 77 on Reader Service Card.

## FIVE CHANNEL MINI-CONSOLE

● This is a completely self-contained three and a half inch rack mount five channel mixer, providing full program, monitor and cue facilities, accommodating up to thirteen microphone inputs. XL-type microphone connectors are provided on microphone inputs one and two. The remaining input and output connectors are screw terminals. Mixers three and four may be switched for either microphone or high level inputs; mixer five will accommodate up to five high or low level inputs through pre-select push buttons, and all input sources may be previewed on a cue bus through the panel mounted cue speaker. The cue amplifier also serves as a talk-back amplifier; provision is made for headphone monitoring. Output is + 18 dB maximum, with  $\pm 1$  dB response and less than 0.5 per cent distortion from 30 to 15,000 Hz. The monitor amplifier provides 4 watts output. Illuminated vu meter, calibrated for + 8 dBm output level

Mfr: McMartin Industries

Price: \$495

Circle 57 on Reader Service Card.



## VERSATILE AMPLIFIER

● A versatile, solid state, line/distribution amplifier, model 109, in the intermediate power range (3 watts), can be used as a distribution amplifier to power numerous outputs, for example fifteen or more with 37 dB to 43 dB gain; high output line or program amplifier for use when unusually high output line levels exist and additional isolated outputs are needed; low output power amplifier for use with dynamic program material of a wide range, with output resistance from zero to infinity and power output up to three watts. Specifications include: gain, 40 dB  $\pm$  0.1 dB; output, 3 watts into impedance from 8 to 50 ohms, +24 dBm into 600 ohms; frequency response, within  $\pm 0.1$  dB from 50 Hz to 50 kHz (50 ohms load); output noise, not over an input equivalent of -122 dBm, undeighted 20 Hz to 20 kHz, input terminated 600 ohms. Will recover from 1000 per cent overload almost instantly.

Mfr: Spectra Sonics

Price: \$75.00

Circle 61 on Reader Service Card.

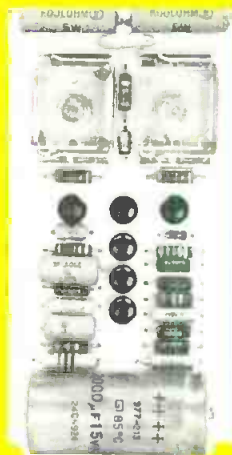





# SCHOEPS

## CONDENSER MICROPHONES

### The Quality Standard Throughout The World



-  A compatible microphone for all powering systems  
 12V Centerfeed      12V Parallel  
 48V Centerfeed
-  Classical acoustic pattern shaping for uniform response
-  Exclusive single diaphragm Hypercardioid pattern
-  World's smallest three pattern condenser microphone
-  Utilizes standard American accessories



**GATELY ELECTRONICS**

57 WEST HILLCREST AVE. • HAVERTOWN, PA. 19083

... have you checked Gately lately? 215-446-1415

Circle 12 on Reader Service Card

## CUSTOM AUDIO CONSOLE



● Four-channel capability is offered by Centurion II custom audio console. Each mixer position is a self-contained plug-in module, internally selectable for high or low level inputs. Up to 12 mixers can be supplied, with three switched inputs to each for a maximum of 36 stereo inputs. Each mixer feeds either the program, audition, or utility busses, any one of which in turn can feed the mono output. The program and audition channels are separately metered so that two adjacent mixers can be used to originate quadriphonic broadcasts or to make four-channel recordings. Either vertical or rotary attenuators are available.

*Mfr: Sparta Electronic Corp.*

*Circle 68 on Reader Service Card.*

## ACETATE-BASE MAGNETIC RECORDING FILM



● An improved high-output, low-noise oxide coating is a characteristic of this new acetate-base magnetic recording film, Scotch brand 337, 338, and 339. The improved oxide coating gives the film a wide dynamic range, similar to that of polyester-based types, but with better resistance to wear and scratching than previously available acetate-based films. The new film is available in full coat, stripe coat and clear edge configurations for 35 mm. and full coat for 16 mm. The 338 stripe-coat film features a 300-mil wide coating just inside the sprocket holes on one side and a balance stripe just inside the opposite sprockets. Both edges and the center of the film are clear to simplify synchronization with pictures or writing of editing directions. 339 clear-edge film, intended for multiple track re-recording, is fully coated except for each edge.

*Mfr: 3M Company*

*Circle 69 on Reader Service Card.*

## PHONO CARTRIDGE

● Superior trackability is claimed by the manufacturer for this new cartridge, featuring a new laminated magnetic core structure and a stylus assembly with a 25 per cent reduction in effective stylus mass. The cartridge has a virtually flat frequency response and an improved dynamic range. The sound is reported to be completely neutral and coloration-free. V-15 Type III has a biradial elliptical diamond stylus and V-15 III-G a spherical diamond stylus, suitable for use with conventional stereo reproduction or four-channel matrix systems. Also available is a biradial elliptical stylus, the VN78E, for playing mono 78 r.p.m. records.

*Mfr: Shure Brothers, Inc.*

*Price: \$72.50*

*Circle 73 on Reader Service Card.*



## MULTI-PURPOSE OPERATIONAL AMPLIFIER

● This developmental power hybrid circuit is a low-distortion, 7 ampere 100-watt linear amplifier, Model TA 8651A, with an output section which can be externally biased class AB for low intermodulation (0.05 per cent at 50 mW) and low total harmonic distortion. Terminals are available for external frequency compensation, external short-circuit protection, and inverting and non-inverting inputs. Produces low distortion (less than 0.1 per cent at 50 mW); recommended for use in such applications as servo amplifiers, p.a. systems, voltage regulators, driven inverters, and power operational amplifiers.

*Mfr: RCA*

*Price: \$12.90 (1,000-unit quantities)*

*Circle 52 on Reader Service Card.*



## COMPACT SPEAKER

● Rhapsody (B-401), measuring 25 $\frac{5}{8}$  inches high by 18 inches wide by 13 $\frac{1}{4}$  inches deep, delivers big sound in situations where space is limited. The three-way floor standing model, finished in walnut veneer, features a top so designed that a marble, glass, or slate slab laid on top converts it to a table. It has a twelve-inch extended travel, high compliance woofer; isolated mid-range; separately installed tweeter; three position brightness switch on the treble. Also available in a shelf model (B-402) with identical components.

*Mfr: Bozak Mfg. Co.*

*Circle 51 on Reader Service Card.*

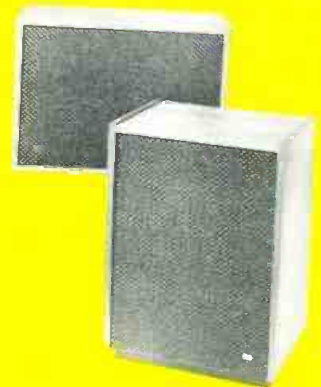

## HIGH RESOLUTION COUNTER



● This new lightweight portable counter module, model 5307A, to be used with the HP 5300 measurement system automatically makes fast measurements of low-frequency events with high resolution; it resolves rpm to 0.001 or frequency to 0.0001 Hz in less than one second. No gate time need be set, or adjustments made for triggering or frequency multiplication. It has an events-per-minute mode to display such readings as rpm or beats per minute. Model 5307A measures frequencies from 5 Hz to 2 mHz by first making a period average measurement for one or more periods (counting its own internal 10-mHz clock), then calculating the corresponding frequency. With all its front-panel controls in "neutral," the 5307A is a fully autoranging, high-resolution counter with 10 mV sensitivity which will operate over its entire specified range without skilled attention. Low-pass filters, at 100 Hz or 10 kHz, may be switched in to make counting possible in the presence of noise or other extraneous high-frequency signals; sensitivity is controllable. To avoid erroneous counting due to bounce, etc., a hold-off inhibits triggering for an adjustable period of time after each main pulse. An input attenuator can cut down high-level signals with high-level noise to the point where the lower levels of noise will fall below the trigger setting, permitting the accurate counting of the main signal. The counter 5307A is one of a number of modules which may be snapped onto the basic model 5300A measurement system, consisting of a six-digit display section. Others are 10-mHz and 525-mHz units, a time interval module and a digital multimeter module. A battery pack, as well as a digital-to-analog converter which produces analog signals proportional to the meter's reading, may be added to any of these.

Mfr: Hewlett Packard

Price: Basic Model HP 5300A, \$395;

Model 5307A, \$350

Circle 63 on Reader Service Card.

# PROKIT

## THE FLEXIBLE MIXER SYSTEM with RAVE REVIEWS!

LARRY ZIDE in

"No kit I have ever built has had the quality of componentry that exists in this unit . . . This unit is fully professional in every way — nothing about it is consumer . . . Well worth the asking price of \$299.00 kit."

db

THE SOUND ENGINEERING MAGAZINE

ED DELL in

" . . . one of the finest pieces of audio equipment available to the home user . . . In use, the SM-6A is the equal of any piece of audio equipment it has ever been our pleasure to use. Intermodulation distortion (60 & 6,000 Hz, 4:1) on the microphone inputs was 0.008% @ 0.6V out. In use the SM-6A is a solid, smooth, well built unit."

the Audio Amateur



### SM-6A MIXER

\$299<sup>KIT</sup> \$499<sup>WIRED</sup>

● 6 mic, 6 line, and 2 mag. phono inputs ● low noise IC circuitry ● VU meters



### EQ-6 EQUALIZER

\$149<sup>KIT</sup> \$299<sup>WIRED</sup>

● individual high and low frequency equalization for each SM-6 input



### EK-6 REVERB UNIT

\$179<sup>KIT</sup> \$325<sup>WIRED</sup>

● 6 individual send controls ● 2 quality reverb springs ● each input assignable to either or both outputs

**P  
K**

PROKIT DIVISION  
GATELY ELECTRONICS  
57 WEST HILLCREST AVE.  
HAVERTOWN, PA. 19083  
215-446-1415

# db Visits—Rupert Neve

*This article was originally scheduled for the April issue but deferred. Rupert Neve is, of course, a major manufacturer of consoles with headquarters in England.*

**T**o visit Rupert Neve and Company—as more and more studio executives in search of top-quality control consoles seem to do each year—you leave London on the Cambridge road. After about forty-three miles, when the urban sprawl has given way to “England’s green and pleasant land,” you reach the charming village of Melbourn. It has only some 3,500 residents, an abundance of genuine old thatched cottages and, tucked among the trees, the neat but continually expanding Neve factory.

I have emphasized the rural setting because the Neve Company—management and employees—do in fact form a kind of family community, with the sense of corporate loyalty and pride in turning out a good product that this implies. However, it was explained to me that Rupert Neve and his wife, while taking an interest in the well-being of their staff, do not regard their role as paternalistic in any way. And the country location does not mean that the Neve organization needs to be regarded as an example of “cottage industry;” far from it.

The end products of this facility, highly sophisticated custom-built audio control consoles, are now exported all over the world. They can be seen in daily, and nightly, use in a surprising number of top studios, where their technical specifications and operational versatility have contributed to very many prestigious record hits, broadcasts and film sound tracks. Creation of these complex mixing desks—some of them massive monsters (such as the 32-input, 24-output Neve desk in a well-known Hollywood recording studio)—calls for very special back-up facilities.

The design engineering team, which works directly with the sales people so that a customer’s requirements can be interpreted and budgeted in minimum time, occupies a newly-completed building behind the main factory. They have a large drawing office at their disposal and feedback of ideas from all types of studio men is relayed by both customer liaison and installation personnel. New suggestions for control layouts or circuit facilities can be evaluated in a fully-equipped listening room where the decision is made whether to build the new idea into the standard 16-in/4-out or 24-in/8-out, etc. console or to offer it as an optional extra.

I was told that the Neve policy of specializing solely in professional audio gear, though for a wide range of studio types, has contributed a great deal to the lead which they now enjoy over other, sometimes much larger, companies. But my own feeling is that the Neve success

story owes less to specialization or to the successful incorporation of user-originated ideas than to the perfectionist approach and design acumen of Rupert Neve himself.

We have to use the hackneyed term, *success story*, to describe an organization that has just about doubled its turnover for each of its bare twelve years of existence. It was only around 1961, having previously run a consumer audio design and manufacturing business, that Rupert Neve was asked by one of his consultancy clients to advise on a studio mixing console. No one seemed to be manufacturing such equipment to anywhere near the close performance tolerances Rupert was specifying; therefore, he built the console in his own garage at home.

It soon became clear that the market needed a firm specializing in this field and Rupert Neve & Co. was formed in 1961. The Neves moved to a delightful old rectory, the “Priesthaus” at Little Shelford (still their home) and put up a 1,200 square foot “factory” building in their yard. The present factory at Melbourn has now expanded to some 26,000 square feet and includes the original factory, which was transported and carefully re-assembled at the new site.

I was intrigued to see the construction process for myself because I first knew Rupert Neve in his consumer hi-fi days, and I have a 16/4 Neve desk in the music department studio at Surrey University—where it takes frequent pounding from my B. Music (Tonmeister) students.

The first stage in constructing a Neve console is to cut from sheet aluminum the vertical end and partition panels to fit the contours dictated by the user’s individual requirements. These panels are joined together by aluminum

*A 16-track console installed in Whitney Studios, Glendale, California.*



*John Borwick is continuing to contribute a series of articles on professional audio in Europe. A resident of Surrey, England, he is deeply involved in both professional and consumer audio—both as a writer and editor.*



*The Neve factory at Melbourn, near Cambridge, England.*

*Neve metalwork shop, showing assembly of the aluminum frames for the consoles.*



*Wiring shop. Approximately fifty consoles are under construction at any one time in the Neve factory.*

*Consoles undergoing comprehensive systems checks in the test department.*



rails, ready-tapped to mate with the various drop-in modules for channel amplifiers, faders, limiter/compressors, etc. For strength, the whole structure is bolted down onto steel base rails, with self-leveling feet.

Before the handsome teak outer panels are fitted on, skilled operators install all the panel hardware, sockets, etc. and wire all the necessary cable harnessing. A feature of Neve desks is that all external connections are made by plug and socket (no fiddling tagboards to solder). Therefore, assuming the customer has done his homework and has suitable cables in readiness, the complete console can be delivered, plugged in, and go through the full sequence of acceptance trials in a single day.

This ready-to-go capability was demonstrated recently in Canada when a Neve console was used in a live broadcast at Le Studios Andre Perry less than twelve hours after arrival at Montreal Airport.

On this question of acceptance trials, Mr. Collier, financial director, recalled to me with a smile how one of their most prestigious customers insisted on coming to the factory to check out his first Neve desk. Following his usual practice, he brought a squad of specialists with a truckload of test equipment and checked into the local hotel for a week. One day later, with all facilities checked out as being well within specifications and completely free of "bugs," they were obliged to cancel their hotel reservations and return to London.

In fact, the test certificates supplied with each Neve desk attain an almost unbelievably high performance standard. The printed specification is tight enough, but the measurements typically achieved (and I have studied a number of them) greatly exceed the basic claims. To

take total harmonic distortion as an example, and Neve measures this at the +20 dBm level (!), their literature claims less than 0.075 per cent and yet a typical test certificate consistently shows less than 0.02 per cent on every channel. Of course, distortion levels like this can only be measured on superb testing equipment. It is the same with cross-talk and noise, where figures such as -100 dB and -125 dB (equivalent input noise) are achieved.

It is surely no coincidence that the improvements in professional recording studio techniques and demands for more and more channels and facilities can be dated from the emergence of such high-quality control consoles. Modern multi-track recordings would probably be impossible if this class of equipment did not exist.

Expansion of the Neve group of companies continues, with sales now around \$3,000,000 a year. While visiting, I saw forty to fifty consoles in various stages of construction. The enthusiasm of the three hundred employees is evident everywhere. Apart from the 26,000 square feet at Melbourn, they now have a 10,000 square foot plant at Kelso in Scotland, where most of the modules are built. Exports go to twenty-seven countries and account for more than fifty per cent of output.

To insure that a full service is provided to North American customers, Neve has set up subsidiary companies: Rupert Neve, Inc. with headquarters at Berkshire Industrial Park, Bethel, Connecticut; a West Coast office at Suite 616, 1800 N. Highland Avenue, Hollywood, California; and Rupert Neve of Canada at 7528 Bath Road, Malton, Toronto, Ontario.

Here, surely, is a company that lives up to its slogan "The sound of Neve is world-wide." ■

# A Modern Recording Studio for Peru

*After reading this article you may find that your ideas of how recordings are made in countries other than the U.S.A. are badly shaken. Still modern equipment is needed, even if the applications are often far simpler than those here.*

**P**UTTING a recording studio together is not just a matter of working out a blueprint for all your brilliant ideas, ordering the equipment, and summoning your favorite genie to make it all come true. Usually, you run smack up against the number one stumbling block, the budget, and have to thread your way in and out of that obstacle course. When working in another country, this ever-present problem is compounded by other challenges, tangible and intangible, such as the type of equipment used in that country, the tastes of the inhabitants and the particular needs of native performers. This is the story of the development of one modern recording studio in Peru, but the challenges met are those often facing engineers working in areas of the world with special needs and comparatively unsophisticated technology.

In Peru, there are eight record factories, all of them located in the capital, Lima. These operate from two to sixteen record presses, bringing the total of record presses in the country to about sixty-two. Six of the eight factories have their own electroplating, five have cutting equipment, and four operate recording studios as well as their production facilities. There are also four small commercial recording studios in the city, but only two of them are more or less acceptable for musical recordings in two-track stereo.

Unlike American recording studios, whose income derives not only from record sales but from diverse sources, such as advertising commercials, radio shows, and educational programs, Peruvian record manufacturers, and their studios, live exclusively on record sales. The country's total sales in this area per annum ranges between 3,500,000 and 4,000,000 records, and of these, many records have been imported from other countries. The export trade is scanty and comprises only masters, no pressed records. The demand for new releases is constant, but the output coming from one stamper pair is extremely low, sometimes only between one hundred and two hundred for a release. Sales of 3,000 copies of an LP, or 8,000 copies of a single, rarely occurring, is considered very good.

Labor is comparatively cheap, but duties on imported materials and equipment are high, bringing up the price of the average LP to about \$4.30 U.S.

The strain on the record companies has been further increased by the increasing complexity of equipment in the hands of Peruvian consumers; they have stereo, compatible recording, and now quadriphonics, and they are naturally demanding recordings in keeping with their equipment. This, in turn, puts the struggling record companies on the spot since they have to update their equipment. Modernizing the average Peruvian record-producing facility with the latest equipment necessary costs more than \$60,000 U.S., a big nut to crack for companies who are barely hanging on.

This was the situation I faced several years ago when called to Peru to plan and install a modernized recording studio. The firm involved was second from top in record sales and, thanks to good management, had fairly good financial backing. In 1964 the company had consolidated their scattered interests, including administration, production, sales offices, retail store, studios, and factories into new buildings. The large studio building was constructed after Philips' architectural design, comprising on the first floor one large and one small studio, each with its own control room. On the second floor of the building were three echo chambers and one room with an EMT 140st reverberation plate. At the time, only the large studio was in operation, with an old Altec console 250 SU and two AMPEX 354 recorders in the control room, with one echo chamber and the EMT plate connected. The cutting department was on the second floor of the factory building (picking up all the vibrations from the machinery over there); equipment consisted of a very old Neumann lathe with Ortofon cutting head and mono amplifier and a more or less historical Philips transfer playback machine.

As to the staff, the only permanent workers were recording and cutting operators, who had grown into their jobs through practice. Recording was done through the production department and cutting through the factory. Service, maintenance, and extensions were provided by temporary workers from outside, who were far from reliable. My first meeting with the management was an effort to create a more workable organization. This was done by introducing a technical department, including four sections: recording, cutting, cassette duplication, and electronic workshop.

---

*Gerhard H. Nieckau is a free-lance consultant who has travelled extensively in his work. He is currently in Trinidad.*

Next, we planned construction work for certain alterations in the existing facilities. First, a new cutting center was created on top of control room number one; secondly, the EMT plate was removed downstairs and the former EMT room was converted into an electronic workshop. Finally, one of the three echo chambers was made into an office. This proved to be a very practical set-up, with studios and control rooms next to the musical instruments retail store on the first floor and on the second floor, the new cutting center, the common entrance to workshop and office, plus the two echo chambers.

When it came to selecting new equipment, the most urgent need was for cassette duplication. Because it normally would have to produce a relatively small quantity (about 300 on first releases, repeats between 20 and 150), the Philips Vienna in-cassette duplicating equipment with six slaves was selected. As to cutting equipment, the only acceptable solution was a new complete Neumann VMS 66 lathe with the SX 68 cutterhead. For master tape reproduction I ordered the Scully T/M, selected because of serviceability, good performance, and low price.

When it came to choosing the right studio equipment, and considering our proposed budget of approximately \$60,000, we came up against two situations which didn't seem to balance out. First it was clear that all old equipment now installed in control room 1 had to be repaired and transferred to control room number 2. Control room 1 would then be cleared out, and a completely new set-up required for the large studio, number 1. Since our budget figure had to cover both recording and cutting equipment and the price of the needed Neumann VMS 66 cutting lathe together with two cutterheads SX 68 (for safety) and necessary supplementary equipment would range around \$30,000, we were not left with sufficient funds to think about something really good for the rest of the equipment.

Before compromising with makeshift arrangements, we stopped to consider just how profitable our studio could be. The management was ready to make the studio available for general use. From my talks with arrangers and bandleaders I found out that, in addition to the obvious increase in sales of records and cassettes that would follow increased production, we could look forward to a good income from the rental of the studio to freelance producers. The producers told me that if the rent was not too high, they were definitely in the market for a studio offering good facilities. Competition would be negligible; none of the existing commercial studios had the intention (nor the money) to extend, to upgrade, or to reconstruct its equipment. We decided that what we were planning was something unique for Peru and that our modernized studio would be indeed a good income-producing venture. Therefore, the company enlarged the budget considerably, permitting the purchase of necessary equipment for a really good studio.

#### HOW MANY RECORDING TRACKS FOR PERU?

After a short analysis of conditions, I came to the conclusion that in Peru the important thing was not having as many recording tracks as possible, but having high-quality equipment, concentrating on facilities for reverberation, echo, equalization, etc. Further, the great need was for employing first-class operators, and offering a reliable technical service.

Regarding the number of recording tracks, it appeared that very few Peruvian producers would be interested in making recordings requiring more than four tracks; the kind of production made in Peru simply doesn't go into anything more complex. About seventy-five per cent of all music produced in Peru is of pure folklorical character:



*The author (at left) at the Neumann console during a training session for recording engineer Jorge Avalos.*

Huaynos, Vals Peruano, various tropical rhythms, etc. Most of the musicians are practically amateurs, unable to read music, playing without written arrangements. Overdubs would be meaningless to this type of musician; he is only happy playing together with his group all at once in the same studio. This type of music will probably be even more important in the future. The government continually agitates for the uplifting of "natural culture," no matter what the artistic level actually is, and at the same time discourages foreign music.

The remaining twenty-five per cent of production includes the typical Latin *baladas*, requiring overdubs of violins, guitars, and voice; regular recordings of police and military bands; finally, there were occasional local productions of classical music, requiring no overdub at all. There are some performing groups of youngsters with a pretty high musical level and the ability to work with any number of recording tracks, but this was not a great enough percentage of the total demand to justify an investment in sophisticated tracking. Although U.S. and English pop music is played, it is restricted by the Peruvian military government (we will see how long the youngsters will be ready to accept that). Some of the groups try to modernize the wonderful Peruvian melodies; others, emulating the well-known *Naufragos* from Argentina and *Los Angeles Negros* from Chile, play a mixture of Latin pop and other modern music. But since the cultural institutions and the ministry of education are full of very old conservative musicians, even these groups do not have much chance to record.

With all these observations in mind, plus the fact that I would later have to buy a second multi-track reproducer, I confined my planning to a four-track set-up.

#### THE EQUIPMENT

The following equipment was acquired.

Tape recorders: Scully model 280-4 M/S (½-inch tape) and model 280-2 M/S (¼-inch). These tape recorders were selected partly because we already had a Scully T/M in the cutting center and also because of other advantages.



*In this view of control room 2, we can see the Altec console and speakers, Pultec equalizers, and two Ampex 354 recorders in custom made cabinets. At the rear can be seen the movable test equipment rack (on a typewriter table) consisting of a group of Sennheiser and Grundig components.*

Mixing desk: Neumann 20/4, custom altered after my layout, with only 16 input amps. We chose this model because of its excellent performance characteristics, safety against overload distortion, and simplicity of the layout.

Limiters: Comp-limiters Universal Audio 1176.

Monitors: for both controls, Altec 605 speakers in model 620 cabinets. Monitor amps for control room one were Altec model 9477A (solid state). Monitor speakers inside studio number 1 were Altec Voice of the Theater (which we already had). For the cutting center, we ordered Heco professional speakers.

Microphones: four new Neumann U 87 and several Beyer ribbons were added to existing U 67 & 60, M 49, and several dynamic mics.

Cue System: power amplifier, Krieger V 225 (mono/stereo); speakers were Heco LZ 100; earphones DT 96V (wireless).

Additional echo unit: Dynacord Echocord Studio, a magnetic disc base with two speeds, four reproduction

*A view inside studio 1. At the left front: percussion baffle with congas. Middle: the drum baffle. Left rear: bass and/or overdub baffle. The session is a typical one for recording of local music.*

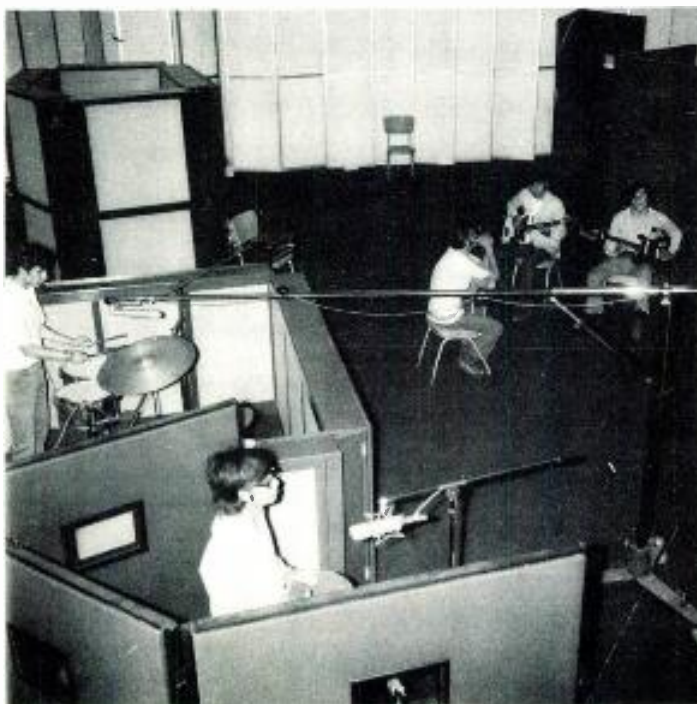

heads, equalization on in- and outputs.

Music amplifiers: Dynacord, one of each—bass, guitar, organ.

Racks: one for auxiliary equipment and additional selector panels; another for a central patch panel. These were 19-inch standard racks for local assembly.

Patch panel: Tuchel contacts, capable of using either simple or switching jacks, as required. There were another two units, each with six pushbuttons, for monitoring and cue track distribution.

Amplifiers for talkback and echo chamber: existing Philips professional type mono power amplifiers were used.

## OPERATIONAL PLANNING

The purpose in moving the cutting department was not only to avoid factory vibrations, but also to have everything concentrated in the studio building where we would have enough space to accommodate both new and existing equipment. Most important, closer contact between recording and cutting operators was facilitated. Even so, coordination between the two operations was not perfect. After some complaints from producers that their records didn't sound as well after cutting as they did during mix-down, I had to be very particular that master tapes leaving the control room were perfect as to level, limiting, and equalization. We trained the recording operators to do exact equalizing and limiting and forbade any alteration during cutting. After the new system was under way, we had no further claims.

Although it was developing that control room 1 was to be the center of operations for recording, overdub, and mixdown, the use of control room 2 was vitally needed as well. In order to use control room 1 in the most efficient and profitable way possible, all operations that might present a hindrance to the smooth flow of production in control room 1 had to be moved out of there. Activities which were assigned to control room 2 included the editing of master tapes, production of promotional copies for radio, t.v., and foreign record companies, as well as informal copies for artists and producers, demo recordings, etc. Another time-consuming activity, which seems to be common in developing countries, was the copying of imported sample records for local release, a job which has to be done with painstaking attention to highest possible quality and editing of the tape so that it is ready for cutting. There also had to be a place out of the way where tapes brought in from outside the country, as well as sales demonstrations of our own products could be played without interfering with other operations. Control room 2 provided that setting.

Finally, the architectural layout of the studios and control rooms offered a lot of possibilities for combination. Control room 1 was located between the two studios; from the operator's site it was possible easily to overlook both studios. The large studio, number 1, could be seen through the window of the mixing desk and the small studio through another window on the operator's right (the window between control room 2 and the small studio was on another wall.) There were doors to the small studio from both control rooms; the two studios were conveniently accessible to each other across a small corridor. I set everything up logically to utilize the many combinations this arrangement offered.

## CIRCUITRY

The above-mentioned operational flexibility of studio occupation clearly required an elaborate network of interconnections. To provide independent operation of the small studio from any of the controls, six separate studio



lines were installed to each patch panel of the two controls. Monitoring and cue operations were separate from each of the controls. The patch panels of control room 1 and control room 2 were interconnected by four lines, two in and two out. This, for example, enabled us to feed a stereo signal from control room 2 to the two compressors in control room 1 and to receive it back. Further, any of the two Ampex 354 recorders in control room 2 could be connected to a transport remote control mounted on the console in control room 1, in case an additional tape recorder was needed for operation in control room 1.

Since there was only one EMT reverberation plate and it had to be available from both controls, we installed one reverb send line, two reverb return lines (EMT stereo), and one signal line between the patch panels of the two controls. In the event the plate was occupied from control room 1, a red warning light prevented users in control room 2 from intervening; another warning flashed when the plate was being used in control room 2. Each of the control rooms had its own echo chamber with interconnecting lines which could be used for either one.

Four other interconnecting lines existed between the patch panel of control room 1 and the SP-66 transfer panel in the cutting center. The two stereo monitor outputs of the console of control room 1 (channels A & C) were wired up to feed, in addition, two monitor amps in the director's and engineers' offices. Finally, control room 1, control room 2, the cutting center, and workshop were linked up to the engineers' office by an intercom.

From studio 1 a total of 24 lines led to the patch panel of control room 1, twelve each from the left and right walls. The jacks inside the studio were distributed two by two over the entire length of the walls so that a microphone or an instrument could be plugged in from practically every place inside the studio. Six studio lines from each side, located in the most occupied studio area, went through switching Tuchel jacks of the patch panel and were directly connected to input channels of the console, following a scheme devised with the cooperation of the engineers. In case the fix connection was convenient for a recording, no patch cords needed to be used; if not, plugging in a patch cord automatically cancelled the connection and the microphone or instrument could be connected to any other input channel. The 24 lines from studio 1, together with the aforementioned six lines from studio 2 brought the total of studio lines incoming to the patch panel of control room 1 to thirty.

The cue amplifier input was fed from the cue selector switch of the Neumann console, the outputs going to a selector panel in the auxiliary equipment rack which permitted the selection of studio 1 or 2 or the listening mode (speakers or earphones). Both studios were wired up with an induction loop around the studio walls for use with the Beyer DT 96 V wireless earphones. An appropriate network installed in the selector panel made it possible for both induction loops to be used together for simultaneous cue track listening in both studios.

For monitoring, the six outputs of the two Scully recorders (1 x 4, 1 x 2) went through a pushbutton switch to the four monitor inputs of the console where they passed through four individual monitor attenuators and a mono/stereo network. Before entering the Altec 9477-A monitor amps, all four lines coming from the monitor output of the console passed through a small patch panel of Tuchel switching jacks in the auxiliary equipment rack, which normally had a direct connection (no patch cord) to the amp inputs but offered the possibility of patching any monitor line to any of the four monitor amp inputs. The outputs of the monitor amps were led to a pushbutton field, 6 x 4, with a corresponding resistor network for



*Peruvian top star Tanja Libertad does a voice overdub in studio 2. She is wearing a Beyer wireless headphone.*

distribution to the four Altec 605 speakers inside control room 1 and the two Altec Voice of the Theater speakers inside studio 1. Any of the six speakers could also be connected to any of the four amplifiers.

Monitoring inside studio 2 was available through two Philips speakers which could be connected to the corresponding jacks either from control room 1 or control room 2. The rest of the circuitry was in no way extraordinary except that, as much as possible, in- and outputs were available through the patch panel. This made for not only the highest possible flexibility of the installation, but also for quick trouble-shooting and measuring service by the local staff.

*Wiring of the patchbay for the installation of the main console for control room 1. A student from the Technical Institute of Lima is being watched by service manager Luis Rodriguez. At the right rear you can partially see the monitor amplifier and speaker selection rack.*

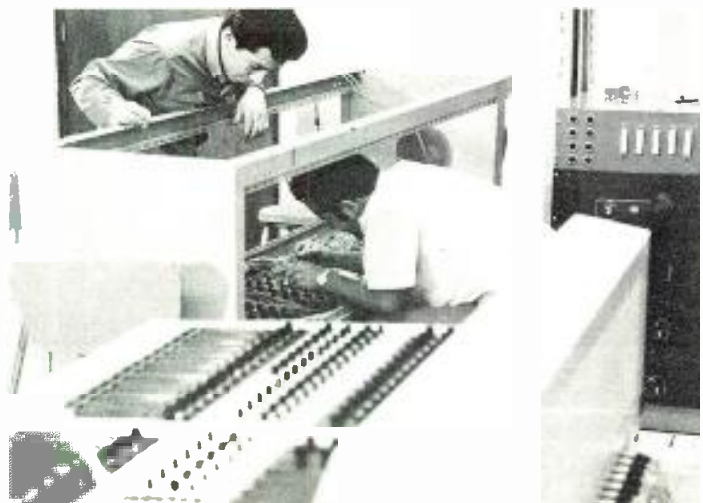



The service area. Service manager Luis Rodríguez is deep into the repair of a ReVox A-77.

Another important task was the right conception of the patch panels. *Right* in this case meant a set-up enabling the local operators to find any needed connection at the very first glance, excluding dangerous confusions between line and microphone levels. A project such as this is not as simple as it seems. Through my work in various continents, I have had to learn my lesson regarding this. What may happen is this; you will design something—a mixing desk, a patch panel, a studio layout, or whatever else, finding it finally perfect in technical and logical respects. When you try to bring the thing into operation with local people, you might, however, find that you are the only person finding it logical; the local technicians and operators just won't dig it. This honestly is *not* under-development or lack of intelligence, but a consequence of local mentality stemming from a different education and life circumstance from yours. Therefore, whenever possible, I consider the local mentality and involve a local staff when making a layout. I followed this policy in Peru and the result was that from the first moment on, people operated the studio as if they had always been doing it.

### SOME PERSONAL OBSERVATIONS

As was the case in some other developing countries where I have worked, I was present in Peru when, for the first time, an obviously superb sound was coming out from the new studio. Even more, I had done the recording myself. But, alas, I was neither regarded as the new Muhammed Ali of the local sound industry nor was the equipment accepted to be the best locally available (although it was that). But this is not disappointing if you really look behind the scene rightly. First of all, people are pretty accustomed to a certain sound characteristic and hence are not able to accept at once something very different, no matter how improved it is.

I remember jumping into a recording session during the very first weeks, still working with the old equipment. I had heard an orchestration with a lot of violins, sounding as if they were in a small size bedroom—dry, dry, dry. Really awful. So I made the operator add a normal quantity of reverb to the violins, thus putting them somewhat backstage and adding presence to rhythm and guitars. For me—and I thought, for everybody else—it sounded just normal then. Well, I'll never forget the sad faces of the musicians when listening to the recording.

In short, it took me about six months to make a breakthrough, more or less convincing the musicians that my way was the normal sound. The only musicians who were with me from the first were the local pop musicians between 16 and 24 years of age. This was logical, because these fellows knew all of the international recordings whereas the old musicians mostly liked to stick to the

sound which, in their opinion, had made their records sell in the past. To change their opinion without hard argument was impossible. But as always in this situation, the arguments came to an end when the first records produced with the new sound sold excellently.

Training of recording operators was generally easy. They caught all the advantages and possibilities the new studio had very quickly. Furthermore, through several years of practice, they had learned how a good recording should sound. My first task was to bring them the evidence that the new equipment would produce this sound, which I did through demonstrating with productions I did myself. Then I taught them all the little tricks of arranging a sound stage the right way. This proved to be pretty rough; during the years of work with partly unqualified producers, band leaders, and arrangers they had received and fulfilled so many confused directions, by this time all their own initiative had been suppressed. But, through witnessing my arguments with musicians and artists and then listening to the results they began to have faith that I had the power and knowledge to do things properly and they finally came around to the safe, correct way of doing things.

Another, very positive, experience was the collaboration with the two Peruvian workshop technicians. Both of them had finished local U.S.-based electronics courses and had worked for a time with a local Philips service center. In addition, each had his own little "moonlighting" workshop at home. This way, both had a fair theoretical and practical base, so training them on professional equipment was not that hard. However, I am sure that I wouldn't have succeeded as quickly as I did if these two gentlemen were not typical middle-class Peruvians, devoted to their jobs and interested in knowing as much as possible. After about two years of our working together, these two men not only were able to manage all current repairs for studios, controls, cutting, duplication, electric and electronic installations at the factory, but were also able to execute a perfect measuring service for controls, the cutting center and duplication activities.

Another valuable collaboration was that with the only reliable dealer in professional electronic equipment in Peru, Estemac Peruana, S.A., representative for Neumann, Scully, and other well-known manufacturers. The manager of the company, Mr. Heinz O Schleusner, had already dealt with the project before my arrival; he and his technician were a big help during installation.

The fine cooperation of these people, plus the fact that the company took a chance on a more realistic financing of the project soon bore fruit. Apart from benefiting from the expected raise of record and cassette sales, the studio was frequented by all of the popular producers. Soon I had to introduce second shifts in the studios. When I left at the end of 1972, studio booking was possible only for at least a week ahead.

Another enjoyable result of the new studio in Lima was that a lot of the compositions and arrangements of a whole group of Peruvian musicians got the sound they deserved, making them internationally acceptable. Various lp's with Peruvian music recorded in our studios were released in France and several other countries and had quite good sales.

Thus, the three years spent in Lima—it was my first Latin American contract—paid off for the sponsoring company and I, as well, had the reward of seeing how my Peruvian colleagues grew to be good operators and technicians. As I left Peru, I was sure that the work would continue in the same way whether I was there or not because my people there learned to love their jobs and to do their very best. ■

# Loudness – Applications and Implications to Audio, part 2

*Last month, the author took us through the nature of sound and attempts to measure it. This concluding section repeats the drawings of last month for clarity, and introduces loudness as it affects actual reproduction of sound.*

**N**OWADAYS one takes for granted the presence of loudness controls or switches on high-fidelity amplifiers. Purists have sneered at the use of devices but even the most ardent of them would admit that some kind of compensation was needed for low-level listening. Certainly one need not be acoustically expert nor musically aware in order to appreciate the loss of bass as volume is reduced.

Consequently, the loudness control came into being. Its prime purpose is to modify the function of the volume control so that bass frequencies are altered less than middle or high frequencies. In other words, as the volume is reduced some bass boost is added. Some loudness compensators boost high frequencies as well.

It has been a frequent observation of critical listeners that such controls are less than perfectly satisfactory. There is no doubt that bass which otherwise would have been very weak or inaudible can be heard after compensation, but the sound may seem to lack realism.

There are good reasons why simple loudness compensation often works badly in practice and why, even in theory, it *cannot* work perfectly.

The equal-loudness contours discussed earlier illustrate some dimensions of the problem. Note, for example, that a reduction of volume (acting equally on all frequencies) will result in a greater reduction of loudness of low-frequency sounds than of middle and high-frequency sounds. At sound levels below about 70 dB the lowest frequencies will have dropped below hearing threshold and will be completely inaudible.

In practice, the situation may be worse than these data suggest. In most listening rooms there is background noise which, although low, may not be insignificant. The effect of background noise is to raise the threshold of hearing by an amount dependent upon the masking effect of the noise. A common form of noise in buildings is that of air-conditioning systems (heating or cooling). Noise from air-handling systems tends to be predominantly low-frequency and as such may mask the more subtle low-frequency sounds of music.

In short, at the lower end of the dynamic range some bass boost will be necessary just to keep the lowest frequencies audible. The dilemma one faces immediately is that sounds nearer the upper limit of the dynamic range require substantially less compensation and the music may therefore appear to be bass heavy.

Let us work through a specific example to see just how serious this problem is. For the purposes of this exercise it is most expedient, if not absolutely correct, to use the pure tone Robinson and Dadson contours (FIGURE 1) since they cover the full dynamic range of hearing.

It is first necessary to make some assumptions about the sound to be reproduced. Let us assume that it has a flat spectrum; this is not accurately representative of any particular musical instrument or group of instruments, but is chosen both for simplicity and as one of an infinity of possible spectra. Let us assume also that the music has a dynamic range extending from a pianissimo 40 dB to a fortissimo 100 dB, and that the ambient noise is well below 40 dB sound-pressure level.

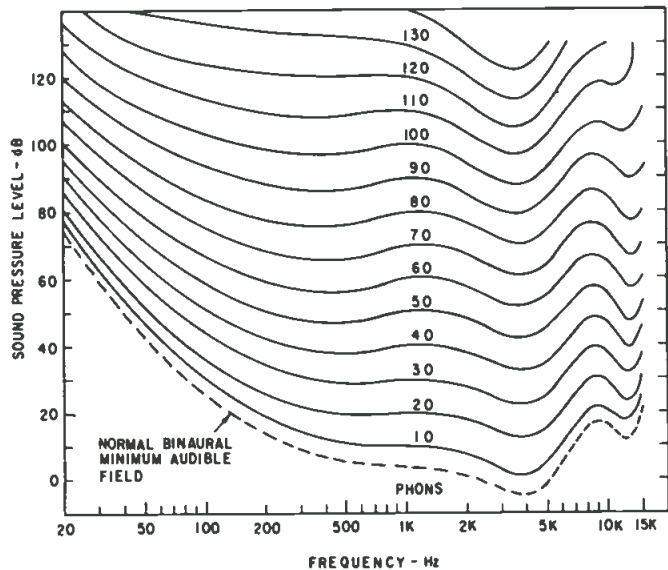

Figure 1. The Robinson-Dadson equal-loudness contours for pure tones. (after 150 Recommendation R226)

Now to pose the problem. In order to reduce the loudness of this music by, say 10 or 20 phons, what new frequency response characteristic must the amplifier have in order that (a) the timbre or spectral balance of the original sound should be preserved in the less loud reproduction, and (b) any frequency audible in the original should be audible in the less loud reproduction? Condition (a) can never be completely satisfied since our perception of the subtle aspects of sound quality is in part determined by sound level. To be more specific, the ear, as a non-linear device, generates distortion products and pitch shifts which are dependent on sound level. These become part of one's mental image of the original sound. Any reduction in sound level, even with the ultimate in loudness compensation, will alter these qualities. Condition (b) is a concession to human nature and really is only a slight distortion of condition (a). If we consider the lowest loudness level to be the threshold of hearing, we are simply requiring that no spectral components audible in the original should be allowed to drop below this loudness level.

With reference to FIGURE 1, let the horizontal line at 100 dB sound pressure level be the spectrum of our sound at full crescendo. You will see that it cuts across several phon contours, starting with a loudness level of about 60 phons at 20 Hz, increasing to about 84 phons at 40 Hz (one must interpolate between the phon contours using

Figure 2. Equal-loudness contours showing the effects of age.

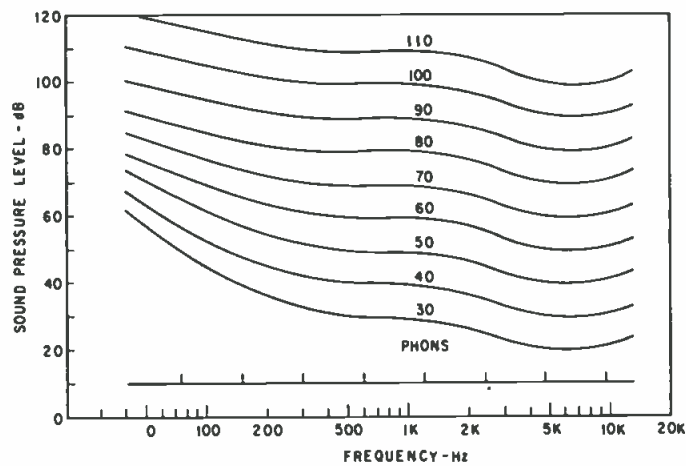
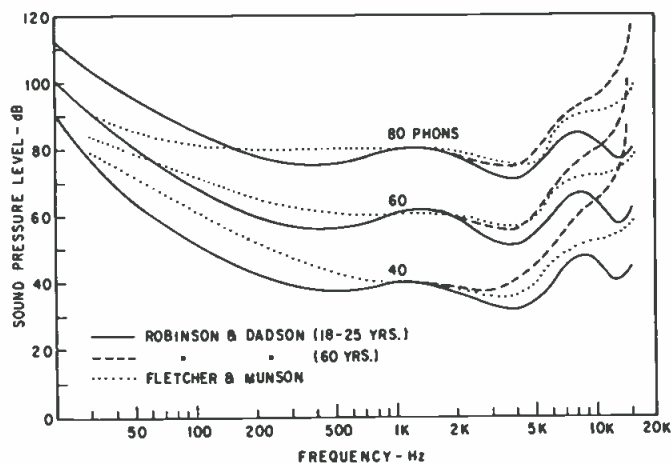
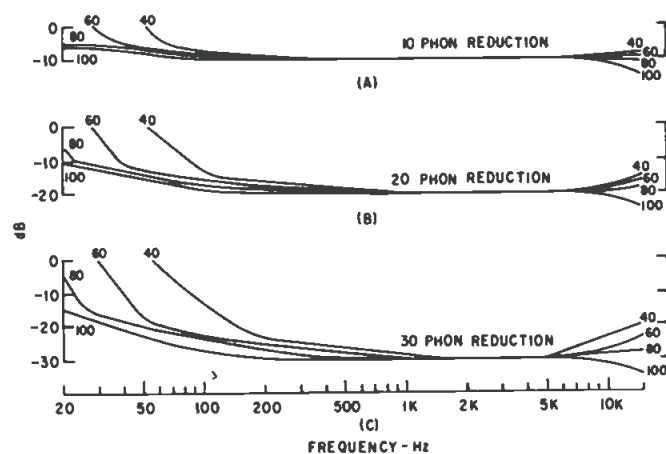

Figure 3. The Stevens equal-loudness contours for octave-bands of noise. (after Stevens, 1957)

an "elastic" scale adjusted to the spacing at any frequency), 103 phons at 500 Hz, and so on. Now, using as an example 20 Hz, move vertically down 10 phons. The amount of change in sound-pressure level is about 6 dB. At 40 Hz the change is close to 7 dB. At 100 Hz the change is 9-10 dB. Through the middle frequencies and, by definition at 1000 Hz, the change is 10 dB. At 15 kHz the change is around 15 dB. In terms of frequency response, a 10 phon loudness reduction would require a slight bass boost and treble cut, compared to the level at 1000 Hz.

So far so good, but let us now move down to consider a sound at the pianissimo level of 40 dB. From FIGURE 1 it is evident that everything below 52 Hz is inaudible. Condition (b) requires that, after the over-all loudness reduction, everything down to 52 Hz should still be audible. This means, of course, that there can be no level reduction at 52 Hz. Frequencies immediately higher than 52 Hz can be reduced only to the threshold of hearing if they are not to be rendered completely inaudible. Only from about 70 Hz upwards, a 10 phon reduction in loudness can be accomplished without dropping below the hearing threshold. At 100 Hz, the change in sound pressure level is 7 dB; at 200 Hz the change is 9 dB; between about 300 Hz and 8 kHz the change is 10 dB; at 15 kHz the change is 8 dB.

Figure 4. The amplifier frequency response required to maintain the apparent spectral balance and audibility of sounds having original sound pressure levels of 40, 60, 80 and 100 dB when the loudness level is reduced (A) 10 phons, (B) 20 phons and (C) 30 phons. Derived from Robinson-Dadson data.



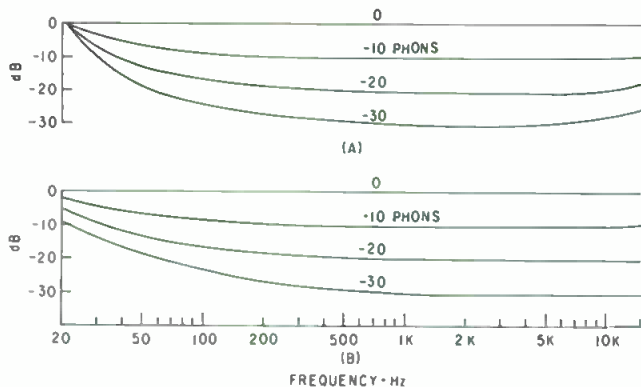

Figure 5. As Figure 4, with modifications described in the text.

Rendered graphically, these frequency responses appear as in FIGURE 4(A) labelled, respectively, 100 and 40. Curves pertaining to original sound pressure levels of 80 and 60 dB are also shown. Clearly, no one form of loudness compensation will satisfy the complete dynamic range of the music. If one corrects for the higher levels (100 and 80 dB) the lower levels will lose bass. If one corrects for the lower levels (60 and 40), the higher levels will sound bass heavy.

Repeating the exercise for 20 phon and 30 phon loudness reductions results in the curves of FIGURES 4(B) and 4(C). The same conclusions may be drawn, but the discrepancies are much larger.

A simple loudness compensator will have only one frequency response at any loudness setting, so we must look for a compromise among these groups of curves. It seems reasonable to neglect the dynamic extremes (100 and 40 dB), as these account for only a small fraction of the total music, and to seek a frequency response intermediate to the 60 and 80 dB curves in FIGURE 4. Doing this, we end up with the curves of FIGURE 5(A) which have been redrawn as frequency responses at various loudness-control settings.

It is questionable whether these curves are desirable in practice. One could reasonably argue that it is not worth striving to maintain equal-loudness or even audibility at frequencies as low as 20 Hz. In fact few recordings have much below about 35 or 40 Hz and those that do, being mainly classical organ music, are likely to be listened to at concert-hall levels. Perhaps, therefore, a further compromise is in order, namely, a straightening of the curves at the very lowest frequencies. Curves modified in this manner are shown in FIGURE 5(B).

It will also be noticed that the high-frequency tilt has been removed. This simply acknowledges the fact that over

Figure 6. As Figure 4, but (A) solid: derived from the Stevens data (Figure 3), (A) dashed: derived from Bauer and Torick data and (B) derived from Fletcher-Munson data.

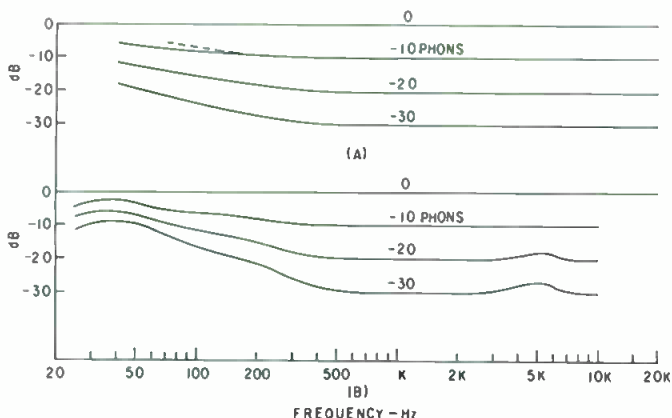

the normal range of loudness adjustment (say 0 to -20 dB), the amount of correction required is so small that it would not be missed. At -30 phons the amount of correction is perhaps significant, but at such a low sound level one is unlikely to be listening very critically.

Having simplified and rationalized the arguments to the point of having some curves which could be implemented, let us briefly ponder the matter of whether it was justified to use the pure-tone equal-loudness contours in this application. Certainly, the octave-band-noise contours shown in FIGURE 3 are different in several respects. However, it turns out that most of the differences don't matter in this instance. Repeating the above exercise for an 80 dB sound pressure level flat-spectrum sound using the contours of FIGURE 3 results in frequency response curves, shown in FIGURE 6(A), which are almost identical to the curves of FIGURE 5.

The single dashed curve in FIGURE 6 resulted from using the very limited data presented by Bauer and Torick<sup>1</sup> who also used octave bands of noise. It, too, is in close agreement with the other curves.

Ironically, the odd-men-out in this exercise are Fletcher and Munson whose loudness data resulted in the frequency-response curves shown in Figure 6(B).

In brief, there is reasonable agreement among results obtained using recent pure tone and octave band loudness data. Inasmuch as one dares to be definite, the curves of Figure 5(B) would seem to be a tolerable compromise between the various conflicting demands of loudness compensation for the kind of sound assumed for this exercise. These curves would be slightly modified if they were developed for sounds of different spectral and dynamic properties.

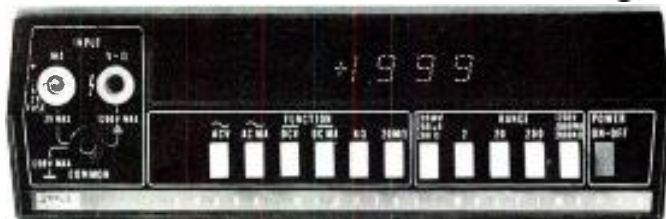

## Think of it as the best tester in your bag. Only \$299

Now you can get a high performance Model 8000A Digital V.O.M. from Fluke, America's foremost maker of quality digital multimeters, especially designed for TV, radio, stereo and audio service. No other digital V.O.M. gives you the resistance range to check breakers and switches, the high resolution voltage to look at emitter base and other transistor voltages, excellent ac accuracy and full accuracy with a 30 second warm-up.

Measures in 26 ranges 100  $\mu$ V to 1200 V, 0.1  $\mu$ A to 2A, and 100 milliohms to 20 megohms with a basic dc accuracy of 0.1%. Full year guarantee. Low cost options include rechargeable battery pack, printer output, deluxe test leads, HV, RF & 600-amp ac current probes, carrying case, and rack mount. Unique self zero eliminates offset uncertainty. Electronics securely mounted in high-impact case. Service centers throughout U.S., Canada, Europe and Far East for 48-hour turnaround repair.



P. O. Box 7428,  
Seattle, Washington 98133.

Get all the details from your nearest Fluke sales office. Dial toll-free 800-426-0361 for address of office nearest you.

Circle 26 on Reader Service Card

Of course the effort and expense of loudness compensation can be properly rewarded only if the sound system is set up and calibrated in such a way that the loudness control setting produces a specific range of sound-pressure levels in the listening room. In practice this is rarely, if ever, done. It cannot be preset at the factory since the signal outputs of phonograph cartridge, tape recorder, and tuner are not standardized and the sensitivities of pre-amplifier, power amplifier, and loudspeakers can vary enormously. Even recorded levels are not absolutely standardized.

Doing the calibration correctly would require recordings of signals at standard levels, and a sound-level meter. The best solution for the audiophile probably is the oldest one: play it by ear. Use the existing loudness control with or without additional help from tone controls to produce the most acceptable sound. The flexibility of the new multifilter type tone controls makes them natural candidates for this kind of experimentation.

### LOUDNESS, SOUND LEVEL AND AMPLIFIER POWER

Let us now briefly consider a matter very much in the audiophile's mind: amplifier power. Having casually observed that a 6 to 10 dB increase in sound level (at middle and higher frequencies) will double the apparent loudness of a sound, let us put this into perspective by noting that this will demand *four to ten times* as much power from the audio system.

A common dilemma is in finding the happy compromise in which the relative merits of amplifier power, lack of distortion, absence of noise, price, etc., have been evaluated appropriately. Serious listeners are frequently concerned with the ability of a sound system to reproduce musical crescendos. In rock terms this can be readily converted into a demand for almost continuous power. In either case, satisfaction is in hearing cleanly-reproduced sound at a loudness which the listener considers appropriate to the music. Inasmuch as loudness is involved, one need not quibble over whether an amplifier has 45 or 50 watts power output. The real decisions involve choosing between, say, 20 and 40 watts or 30 and 80 watts; these differences *will* be significant (assuming of course, that other factors are equal and that the loudspeakers and listening room demand that amount of power).

Clearly, it is the power *ratio* that matters in these instances. A 100 per cent increase in power raises the sound pressure level by 3 dB, which, using the sone scale, results in only 25 per cent increase in loudness. On the other hand, a 5 per cent power increase results in only a 0.2 dB increase in sound level, which translates into an insignificant change in loudness.

### SUMMARY AND CONCLUDING REMARKS

Loudness is a subjective quantity dependent on a variety of factors few of which have been studied in any detail. Arguments based on existing knowledge must therefore be treated cautiously.

It appears certain, however, that in the reproduction of sound, critical listeners are likely to be satisfied only with a loudness level comparable to the original. However, due to the rather different acoustical and aesthetic circumstances of concert hall and living room it can not be stated with certainty that this will require identical sound-pressure levels.

Any significant reduction in volume will result in altered spectral balance (timbre changes) and some loss of bass. With simple loudness compensation one can maintain audibility of the low-level low-frequency components at the expense of accentuated bass in higher-level components.

Obviously, in critical listening evaluations of audio equipment, such as loudspeakers, it is absolutely impera-

tive that loudness compensation *not* be used and that the sounds being compared be of *equal* loudness. Furthermore the listening must be done at a realistic sound level, otherwise spectral deviations introduced by the loudness characteristics may dominate the judgment.

In the measurement of noise, weighing networks are frequently used to discriminate against low frequencies since these contribute less to over-all loudness and are, therefore, least annoying. In normal evaluations of signal-to-noise ratio, an unweighted measurement is likely to be the least instructive. For example, it is well known that turntable rumble 40 dB below a reference sound level is much less bothersome than, say, tape hiss at the same level. Rumble becomes rapidly more objectionable as higher-frequency components become apparent, particularly if these are tonal in quality. From FIGURE 1 it is evident that, even if the main rumble components are, for example, in the vicinity of 30 Hz one must be wary of other components, at, say, 60 and 120 Hz which may be equally audible at levels about 20 and 35 dB lower! This almost certainly is why some turntables having measurably identical rumble have distinctively different audible rumble.

A fact well known to experienced music-listening ears is that some loudspeakers are capable of more satisfying performances at low listening levels than are others. In some cases the cause is all too evident—there is simply a hump in the low-frequency response which at higher levels becomes an annoying bass boom. In short the loudness compensation is built in; the problem is that it cannot be switched out. Between this extreme case and the "flat" speaker are numerous shades of bass enhancement in the speaker system itself. Unless the design and construction are impeccable, speaker systems offer a lot of scope for acoustical and structural resonances. It is possible for these resonances to provide just enough bass enhancement for low-level listening and yet not be overly offensive at normal levels. Of course, any of these characteristics detract from the fidelity of the sound and, strictly speaking, should be avoided. The loudness compensation should be in the electronics, not in the speaker system.

In this discussion I have pointed out just some of the ways that even a superficial knowledge of one's perception of loudness can be useful in clarifying some of the common problems in audio. The perceptive reader will undoubtedly think of others. ■

### REFERENCES

1. H. Fletcher and W. A. Munson, "Loudness, Its Definition, Measurement and Calculation," *Jour. of Acoust. Soc. of Amer.*, Vol. 5, pp. 82-108, 1933.
2. D. W. Robinson and R. S. Dadson, "A Re-determination of the Equal-loudness Relations for Pure Tones," *British Jour. of App. Phys.*, Vol. 7, pp. 166-181, 1956.
3. S. S. Stevens, "Calculating Loudness," *Noise Control*, Sept. 1957, pp. 11-22.
4. B. B. Bauer and E. L. Torick, "Researches in Loudness Measurement," *IEEE Trans. on Audio and Electroacoustics*, Vol. AU-14, No. 3, pp. 141-151, 1966.
5. S. S. Stevens, "The Measurement of Loudness," *Jour. of Acoust. Soc. of Amer.* Vol. 27, pp. 815-829, 1955.
6. R. M. Warren, "Elimination of Biases in Loudness Judgments for Tones," *Jour. of the Acoust. Soc. of Amer.* Vol. 48, pp. 1397-1403, 1970.
7. S. S. Stevens, "Perceived Level of Noise by Mark VII and Decibels (E)," *Jour. of Acoust. Soc. of Amer.* Vol. 51, pp. 575-593, 1972.
8. Zwicker, E., "A Means for Calculating Loudness," *Acoustica*, Vol. 10, p. 304, 1960.
9. H. F. Olson, "The Measurement of Loudness," *Audio*, Vol. 56, pp. 18-22, Feb. 1972.



As a service to our readers we are pleased to offer books from prominent technical publishers. All prices listed are the publishers' net. Shipping charges are included.

To order use the coupon at the bottom of the page. Indicate quantity on the special instructions line

If more than one copy of a title is wanted. Full payment must accompany your order. We cannot ship c.o.d. Checks or money orders should be made payable to Sagamore Publishing Company, Inc. Because of the time required to process orders, allow several weeks for the receipt of books.

# BOOKCASE

**20. The Audio Cyclopedia (2nd ed.).** *Dr. Howard M. Tremaine.* New and updated, here is the complete audio reference library in a single volume. It provides the most comprehensive information on every aspect of the audio art. This new edition includes the latest audio developments including the most recent solid-state systems and integrated circuits. It covers all subjects in the fields of acoustics, recording, and reproduction with more than 3400 related topics. Each topic can be instantly located by a unique index and reference system. More than 1600 illustrations and schematics help make complicated topics masterpieces of clarity. 1760 pages; 6½ x 9¾ hardbound. **\$29.95**

**1. The Technique of the Sound Studio.** *Alec Nisbett.* This is a handbook on radio and recording techniques, but the principles described are equally applicable to film and television sound. 264 pages; 60 diagrams; glossary; indexed; 5½ x 8½; clothbound. **\$14.50**

**7. Acoustical Tests and Measurements.** *Don Davis.* Provides solid understanding of the entire subject of acoustical measurements; based on actual field test work, using commercial equipment. 192 pages; 5½ x 8½; hardbound. **\$6.95**

**8. Handbook of Electronic Tables & Formulas, (3rd edition).** A one-stop source for all charts, tables, formulas, laws, symbols, and standards used in electronics. Includes an 8-page, full-color fold-out chart showing latest FCC allocations for the entire frequency spectrum. 232 pages; 5½ x 8½; hardbound. **\$5.50**

**24. Basic Electronic Instrument Handbook.** *Edited by Clyde F. Coombs, Jr. Hewlett-Packard Co.* A basic reference background for all instruments. Offers saving in time and effort by having complete information in one volume on how to get the most benefit from available devices, how to buy the best instrument for specific needs. Reduces chances of costly errors. Ideal reference book, it is an excellent source for the beginner, technician, the non-electrical engineering man, or general non-engineering scientific and technical personnel. 800 pages. Hardbound. **\$28.50**

**25. Operational Amplifiers—Design and Applications.** *Burr-Brown Research Corp.* A comprehensive new work devoted entirely to every aspect of selection, use, and design of op amps—from basic theory to specific applications. Circuit design techniques including i.c. op amps. Applications cover linear and non-linear circuits, A/D conversion techniques, active filters, signal generation, modulation and demodulation. Complete test circuits and methods. 474 pages. **\$15.00**

**26. The Design of Digital Systems.** *John B. Peatman.* Textbook for students desiring to develop a creative approach design capability through digital systems approach. Answers these questions: Under what circumstances it is desirable to implement a system digitally? What are some of the components available for implementing the system? How do we go about designing it? 448 pages. **\$15.50**

**31. Solid-State Electronics.** *Hibberd.* A Basic Course for Engineers and Technicians. An extremely practical reference book for anyone who wants to acquire a good but general understanding of semiconductor principles. Features questions and answers, problems to solve. 1968. 169 pp. **\$9.95**

**32. Circuit Design for Audio, AM/FM, and TV.** *Texas Instruments.* Texas Instruments Electronics Series. Discusses the latest advances in design and application which represent the results of several years research and development by TI communications applications engineers. Emphasizes time- and cost-saving procedures. 1967. 352 pp. **\$14.50**

**35. An Alphabetical Guide to Motion Picture, Television, and Videotape Productions.** *Levitán.* This all-inclusive, authoritative, and profusely illustrated encyclopedia is a practical source of information about techniques of all kinds used for making and processing film and TV presentations. Gives full technical information on materials and equipment, processes and techniques, lighting, color balance, special effects, animation procedures, lenses and filters, high-speed photography, etc: 1970. 480 pp. **\$24.50**

**40. Radio Transmitters.** *Gray and Graham.* Provides, in a logical, easy-to-understand manner, a working knowledge of radio transmitters for quick solution of problems in operation and maintenance. 1961. 462 pp. **\$16.00**

**23. Wide Screen Cinema & Stereophonic Sound.** *M.Z. Wyszozky.* First published in USSR in 1965 this excellent English translation covers wide gauge films, panoramic films, circular panoramic cinematography; technical fundamentals of stereo sound recording for film, as well as details of the Soviet systems now in use. 284 pages. **\$15.00**

**33. Noise Reduction.** *Beranek.* Designed for the engineer with no special training in acoustics, this practical text on noise control treats the nature of sound and its measurement, fundamentals of noise control, criteria, and case histories. Covers advanced topics in the field. 1960. 752 pp. **\$19.50**

**16. Magnetic Recording.** *Charles E. Lowman.* Reference guide to the technology of magnetic recorders used in audio recording, broadcast and closed-circuit TV, instrument recording, and computer data systems. Includes latest information on cassette and cartridge recorders; TV recorders; direct and FM signal electronics from low to wideband; servo-control and signal record/playback circuitry; capstan, reel, and head-drum servos for longitudinal, rotary, helical-scan, and disc recorders. Glossary, index, bibliographical information. 274. pp. **\$14.50**

**28. Environmental Acoustics.** *Leslie L. Doelle.* Applied acoustics for those in environmental noise control who lack specialized acoustical training. Basic information in comprehensible and practical form for solving straightforward problems. Explains fundamental concepts; pure theory minimized. Practical applications stressed, acoustical properties of materials and construction listed, actual installations with photos and drawings. Appendixes illustrate details of 53 wall types and 32 floor plans and other useful data. 246 pgs. **\$18.50**

**21. Acoustics—Room Design and Noise Control.** *Michael Rettinger.* 1968. The enormous problems and hazards presented by noise are dealt within an orderly and practical manner. With many charts, graphs, and practical examples, the text covers the physics of sound, room acoustics, and design, noise and noise reduction. 392 pages. **\$17.50**

**22. Acoustics of Studios and Auditoria.** *V.S. Mankovsky.* Basic theory plus a mass of design data covers the field with special reference to studios and places of public performance. For acoustical designers and specialists in sound transmission in cinema and broadcasting. Features exhaustive treatment of studio acoustics by the statistical, geometric and wave methods in parallel. 416 pgs. **\$15.00**

**Sagamore Publishing Company, Inc.**  
980 Old Country Road,  
Plainview, N.Y. 11803

Please send me the books I have circled below. My full remittance in the amount of \$\_\_\_\_\_ is enclosed. N.Y. State residents add 7% sales tax.

1	2	3	4	5	6	7	8	9	10	11
12	13	14	15	16	17	18	19	20		
21	22	23	24	25	26	27	28	29		
30	31	32	33	34	35	36	37	38		
39	40									

Name \_\_\_\_\_

Address \_\_\_\_\_

City \_\_\_\_\_

State \_\_\_\_\_ Zip \_\_\_\_\_

Special Instructions \_\_\_\_\_

Canada and foreign: Add \$1.00 per book

# CLASSIFIED

Closing date is the fifteenth of the second month preceding the date of issue. Send copy to: Classified Ad Dept.  
db THE SOUND ENGINEERING MAGAZINE  
980 Old Country Road, Plainview, New York 11803

Rates are 50¢ a word for commercial advertisements. Non-commercial and employment offered or wanted placements are accepted at 25¢ per word.

---

## FOR SALE

---

---

PRE-EQUALIZED J.B.L. MONITORS; Little Dipper hum/buzz notch filters; Cooper Time Cube echo-send-delay; B.B.C. reference monitors; Lamb "B" Dolby processors; Ortofon ultra-track cartridges; Schöeps/A.K.G. condensers; Buyer ribbons; U.R.E.I. comp/limiters; Gately pro-kits; Infinity electrostatics; Crown amplifiers/recorders; dozens more, plus class (A) warranty service station. Shipped prepaid/insured from **Music & Sound Ltd., 11½ Old York Rd., Willow Grove, Pa. 19090. (215) 659-9251.**

---

TWO-CHANNEL MONITOR EQUALIZERS for your Altec's and J.B.L.'s are a steal at \$150. **Music & Sound, Ltd., 11½ Old York Rd., Willow Grove, Pa. 19090. (215) 659-9251.**

---

SOLID-STATE AUDIO MODULES. Console kits, power amplifier kits, power supplies. Octal plug-ins—mic, eq, line, disc, tape play, tape record, amplifiers. Audio and tape bias oscillators. Over 50 audio products, send for free catalog and applications. **Opamp Labs. Inc., 172 So. Alta Vista Blvd., Los Angeles, Ca. 90036. (213) 934-3566.**

---

AUDIOTECHNIQUES, INC. WANTS TO BUY your used Scully Model 280 series tape recorders, any width from quarter inch to two inch. Write or phone Bob Berliner or Ham Brosious giving condition, serial number and configuration. **Audiotechniques Inc., 142 Hamilton Avenue, Stamford, Conn. 06902. (203) 359-2312.**

---

NEW YORK'S LEADING supplier of professional audio/video equipment and hi-fi stereo components. All major brands in stock. Call for quote—sales—service—leasing—trade-ins. **Martin Audio, 320 West 46th Street, New York, N.Y. 10036. Telephone: (212) 265-6470.**

---

AMERICA'S LARGEST SELECTION of new and used broadcast and recording equipment! Latest bulletins available. **The Maze Corporation, P.O. Box 6636, Birmingham, Ala. 35210.**

---

WHATEVER YOUR EQUIPMENT NEEDS—new or used—check us first. Trade your used equipment for new. Write for our complete listings. **Broadcast Equipment & Supply Co., Box 3141, Bristol, Tenn. 37620.**

---

CROWN TAPE RECORDERS, amps; IMF monitor speakers; AKG professional microphones; UREI limiting, Little Dipper; Fairchild; Crown warranty service station, more. **Barclay, 503 Haverford Avenue, Narberth, Pa. 19072. (215) 667-3048. or 120 Villa Crest Dr., State College, Pa. 16801. (814) 238-1598.**

---

HAECO announces complete repair service and overhaul for all Westrex cutterheads. Conversions of 3D-II and older models to higher performance standards and reliability. Helium cooling systems and hi-temp coils can protect your investment. Repair insurance program available. Rapid service. Lower cost. **HAECO, 14110 Aetna, Van Nuys, California 91401.**

## MULTI-TRACK

8 and 16

TRACK RECORDING CONSOLES  
THE SOUNDEST DOLLAR SPENT  
IN PRO AUDIO TODAY

1965 CHEREMOYA AVE.,  
HOLLYWOOD, CALIF. 90028  
P.O. Box 3187, Hollywood, CA. 90028  
(213) 467-7890



SAVE ON YOUR STYLUS COSTS! World's finest recording styli for all Westrex 3D models and HAECO SC-2. \$13.80 unwired, \$14.80 wired. Quantity purchases at additional savings. Satisfaction guaranteed. Send check or money order with your order to HAECO, 14110 Aetna St., Van Nuys, Ca. 91401.

ONE STOP FOR ALL your professional audio requirements. Bottom line oriented. F.T.C. Brewer Company, P.O. Box 8057, Pensacola, Florida 32505.

CROWN CX 822, used. Barclay (dealer) 503 Haverford Ave., Narberth, Pa. 19072. (215) 667-3048.

RECONDITIONED PRECISION TAPE REELS, as new; 1 x 10½-inch—10/\$35.00. 2 x 10½-inch—10/\$70.00. Free list. Wide Response, 2926 Bentley Ave., Los Angeles, Ca. 90064.

SCULLY M-100 16-track brand new tape recorder; tape counter; 8-track conversion kit; spare electronics cards; new type electronics. Asking \$13,000. Jim Bruzzese, Pampa Recording Studios, 31925 Van Dyke Ave., Warren, Michigan 48093. (313) 939-3340.

8-CHANNEL AMPEX, AG 440 transport in floor cabinet (like new); custom built electronics; 8-in, 8-out board; mixdown board with panning; ½ inch heads. \$3,000. Jerry Wallace, 123 Bellvue E., Seattle, Washington 98102. (206) 323-8662.

PLASTIC REELS for mag tape shipped from inventory by the manufacturer of Amerline reels. Polyline Corp., 2449 N. Western Ave., Chicago 60647. Call (312) 489-1757 for immediate shipment.

RECORDING CONSOLE, custom built; 12-in/8-out; extremely versatile; outgrown by expanding studio. \$8,000. Photograph and full details on request. Veritable Recording. (215) MA 2-6060.

TASCAM MIXING CONSOLES—\$1,890. Tascam ½-inch recorders — \$1,950. Shipped prepaid/insured including free alignment and calibration. Music & Sound, Ltd., 11½ Old York Rd., Willow Grove, Pa. 19090. (215) 659-9251.

TELEX 230, four channel recorder with sel-sync and compressor for each channel. Write for particulars. Head Sound, Inc., 7215 Jackson Road, Ann Arbor, Michigan 48103.

2" BY 10½" PRECISION TAPE REELS reconditioned as new, \$5.00 each. Accurate Sound, P.O. Box 2159, Garland, Texas 75041. (214) 278-0553.



**CATV—MATV PRODUCTS**

- CONNECTORS
- WALLPLATES
- SPLITTERS
- AMPLIFIERS

**AVA ELECTRONICS CORP.**  
416 LONG LANE, UPPER DARBY, PA. 19082  
215—MA 6 9100

STUDIO TAPE ELECTRONICS. Advanced design incorporates all the desired features for updating or expanding outdated recorders or building new systems. Prompt delivery. Inovonics, Inc., 1630 Dell Avenue, Campbell, Ca. 95008.

ONE AMPEX AG440-8 eight track with servo: immediately available; "demonstrator." Call collect (305) 776-4762. Broadcast Automation Associates, 5199 N.E. 12th Avenue, Oakland Park, Florida 33308.

LOWEST PRICES for stereo masters expertly cut on a Scully lathe with the Westrex 3D stereo cutting system. Stereo: 12-inch—\$33 per side; 7-inch—\$14 per side. Mono: 12-inch—\$22 per side; 7-inch—\$9 per side. We also cut demos—prices even lower. Trutone Records, 6411 Bergenwood Ave., North Bergen, N.J. (201) 868-9332.

SPLICE FASTER, BETTER BY SHEARING . . . replaces razor; specify .250-inch or cassette: \$16.95. With attached splicing tape mechanism, \$24.95. Details—NRP Box 289, McLean, Va. 22101.

ONE AMPEX 3200 DUPLICATOR SYSTEM; one master, two slaves; mono; full track two-track stereo; stacked stereo heads; "demonstrator." \$7,000. Call collect (305) 776-4762. Broadcast Automation Associates, 5199 N.E. 12th Avenue, Oakland Park, Florida 33308.

ONE AMPEX AG440-8, EIGHT TRACK recording machine; used less than one year (studio going 16-track). \$7,500. Call collect (305) 776-4762. Broadcast Automation Associates, 5199 N.E. 12th Avenue, Oakland Park, Florida 33308.

BROADCAST AND RECORDING EQUIPMENT: Scully; Metrotech; Langevine; Electrodyne; Q.R.K.; Micro-Trak; M.R.L.; Nortronics; McMartin; U.R.E.I.; Neumann; E.V.; A.K.G.; Sennheiser; Tascam; Atlas; Ferrograph; HAECO; Stevenson; Gately; D.B.X.; Advent; Altec; Fairchild; Audio Designs; 3 M; Magnacord; Telex; Inovonics; disc recording systems; package deals; installations; service. Wiegand Audio, Middleburg, Pennsylvania 17842. (717) 837-1444.

## WANTED

EMPLOYMENT WANTED: ENGINEER, experienced in all phases of recording, mixing, maintenance, construction, and design as well as in music, seeking position with larger studio; interest and expertise in music recording as well as commercial. For resume and further information write Box 51 db Magazine, 980 Old Country Road, Plainview, N.Y. 11803.

EXPERIENCED in professional lighting/sound control; package design; construction; solid technical background; BSEE with credits toward MSEE. Seeking design position in Southern California. For resume, reply to Box PM, 1125A Loma St., Long Beach, California 90803.

FINANCIAL PARTNER needed to start eastern Alabama recording studio. Only serious replies please. J. Baldwin, c/o The Music Center, Midway Plaza, Opelika, Alabama 36801.

## EMPLOYMENT

STERLING SOUND has an opening for an experienced disc-mastering engineer. Call or write Sterling Sound, Inc., 110 W. 57th St., New York, N.Y. 10019. (212) 757-8519.

RECORDER SERVICE ENGINEERS. Several experienced men needed immediately for expanding field service force; opportunity to work with latest developments in recording; equal opportunity employers. Vince Lopresti, Scully/Metrotech, 475 Ellis Street, Mt. View, California 94040. (415) 968-8389.

WE ARE LOOKING for a knowledgeable go-getter to sell turnkey audio studios and professional components in several states in the Northeast. If you want opportunity, here it is. Excellent compensation. We represent over 100 top major lines. It's hard to miss a sale. Send your resume to Larry Grossberg, Martin Audio Corp., 320 W. 46th St., New York, N.Y. 10036.

MULTI-MEDIA ENGINEERING SUPERVISOR needed for large midwestern electronics contractor; knowledge of sound, CCTV, audio-visual projection equipment essential. Will be responsible for supervising installations of complex audiovisual systems requiring close liaison with and training of owner's personnel. E.E. or P.E. helpful. Good pay and generous profit sharing program. Send complete resume with salary history to Box 53, db Magazine, 980 Old Country Rd., Plainview, N.Y. 11803.

# PEOPLE, PLACES, HAPPENINGS

● **Ronald Montgomery** has been appointed president and chief executive officer of **Collins Radio Company of Canada, Ltd.** Mr. Montgomery fills the position left vacant by **R. D. Hanson**, who has been assigned to a senior management post at Collins' Cedar Rapids, Iowa operation. Montgomery was formerly associated with **Computing Devices of Canada, Ltd.**, a subsidiary of **Control Data Corp.**, as vice president of marketing. Before that, he was a defense service scientific officer for the Defense Research Board in Ottawa.

● **Video Expo IV**, the fourth annual international exposition of private, closed circuit and cassette video delivery systems and programming, will be held September 18 through September 20, 1973 at New York's **Commodore Hotel**. Over 3,000 industrial television system operators, instructional t.v. administrators, programmers, dealers and others active in these fields will take part. In addition to the usual displays of film and tape cassette systems, cameras, etc. there will be a large display of programming and two workshops. **Media & Methods Magazine** will sponsor a workshop aimed at the educational media specialists. At this time, **Smith Mattingly Productions** of Washington, D.C. will coordinate the portion of the workshop dealing with such subjects as the operation of a single camera vtr system, vtr feedback and "hand on" techniques. The **International Industrial Television Association's** Eastern Region will sponsor the other workshop, which will be aimed at video users who have passed the beginner stage and use multicamera systems. Signal analysis, audio procedures video and software distribution systems and remove shows will be among the subjects discussed. The Expo will also feature the **Video Publishing Conference**, highlighted by knowledgeable speakers discussing the latest uses and design of video software. For further information, contact **Eliot Minsker, Knowledge Industry Publications, Tiffany Towers, White Plains, N.Y. 10602, (914) 428-5400.**

● The **National Association of Broadcasters** has announced the reassignment of **Richard Wartell** from mid-west regional manager to code subscription manager, station relations department. **Steven Farabi** will replace Mr. Wartell. Mr. Wartell will be managing NAB's code new-subscriber campaigns.



● Retake of an historical event is shown in these photos. At top, the three inventors of the transistor, left to right, Drs. **John Bardeen**, **William Shockley**, and **Walter H. Brattain** shown in 1948 at **Bell Telephone Laboratories** with their invention . . . at bottom, the same trio at a 1972 twenty-fifth reunion. They are still contributing to the electronics industry . . . Dr. Shockley is a professor of engineering sciences at **Stanford University**; Dr. Bardeen, who teaches graduate physics at the **University of Illinois**, recently was named to receive his second Nobel Prize for Physics; Dr. Brattain teaches undergraduates physics at **Whitman College** in Walla Walla, Washington. Not pictured is **John Pierce**, who named the transistor as a contraction from "transfer resistor," and is now teaching at the **California Institute of Technology.**

● **David Freese**, formerly director of engineering for **Watermark, Inc.**, has moved to **Audio Industries Corporation, of Los Angeles.** Well known in broadcasting circles, Mr. Freese has also been active for twenty years in all aspects of professional audio work, including sound reinforcement and recording. He will continue his association with **Watermark** on a consultation basis.

● C-O leader loaded and tape loaded cassettes as well as cassette component parts and certain accessories are being offered by **Athenia Industries, Inc.**, of Clifton, New Jersey, a newcomer to the magnetic tape products industry. According to **Jules L. Sack**, vice president of marketing and sales, **Athenia** will handle all phases of the manufacturing process at its own plant, thereby insuring quality control.

● A European branch, located at High Wycombe, near London, England, has been opened by **Cetec, Inc.**, of North Hollywood, California, facilitating the European distribution of its **Electrodyne** and **Langevin** audio control equipment and **Gauss** tape duplicators. **Brian Wills** has been appointed manager of **Cetec's** plant in the United Kingdom and will direct European sales. Mr. Wills was previously associated with **Cetec** as the United Kingdom sales representative for **Gauss** tape duplicators.

● A new firm, **Dahlquist, Inc.**, headquartered at Freeport, N.Y., has been formed, combining the talents of industry pioneer, **Saul B. Marantz** and loudspeaker designer **Jon G. Dahlquist.** The firm plans to manufacture a high-end line of loudspeaker systems based on a new acoustical technique. Their first effort is model **DQ-10**, a four-way dynamic system arranged in an unusual acoustical configuration with listening characteristics similar to those of a full range electrostat, but without the problems in bass response and high frequency beaming often associated with electrostats. Distribution will be through franchised dealers.

# StopClock

**A New, Accurate, Digital Timing Instrument for Recording Studios, Broadcasters, and Other Demanding Applications**

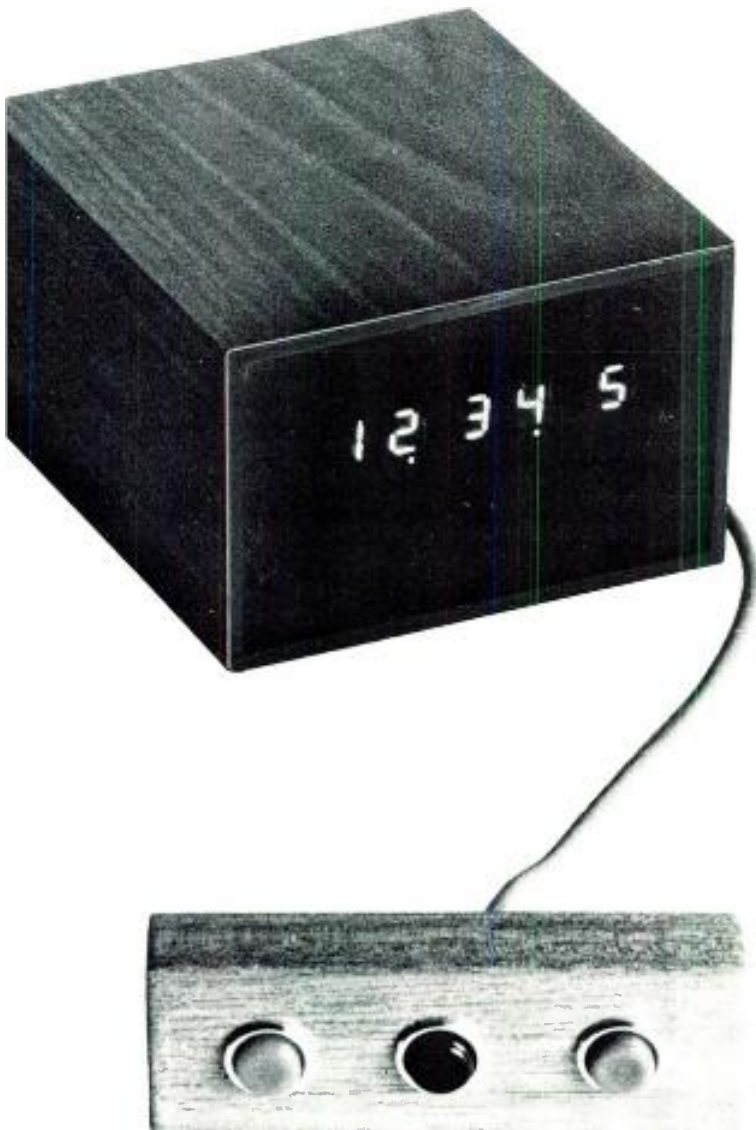

Timekeeper is proud to introduce a new inexpensive *Electronic StopClock*—a compact instrument featuring an easily-read visual display.

Only 5½" wide x 3¼" high x 5½" deep, it uses modern digital circuitry to provide accuracy of a very high order with exceptional long term stability. The large ¾" high, seven-segment numerals can easily be read from a distance of more than 15 feet. Maximum count is one hour (59:59:9).

Three remote-mounted push buttons are used for manual control: START, STOP, and RESET. These buttons may be placed in a console, operating desk or any convenient location. The clock may be remotely located in the equipment, or on a desk or table. (A mounting flange is provided.)

Operation is similar to any conventional stopwatch. The green button starts the clock; the red button stops it. The black button resets it to zero. These may be depressed in any order, or all at once, without damage to the clock. If it is desired to start the clock by releasing a button rather than depressing one, the green and black button are pressed simultaneously. When the black button is released, the clock will start automatically.

The accessory plug on the rear panel may be used for all remote operations. All BCD information is available at this plug for accessory units such as digital printers, slave units, etc.

The Model T-1 is supplied for 120 volt 60 Hz operation, in an attractive simulated walnut grained enclosure with a red lucite face. However, 120-volt 50 Hz operation is available at no extra charge if so specified at the time you place your order.

The Model T-1 is priced at \$185.00. As with all Timekeeper products, it is fully guaranteed to meet with your complete satisfaction, or your money will be promptly refunded. It is guaranteed for one year against any defects in manufacturing.

The Timekeeper Electronic StopClock is a must. More than a high quality timer—it provides the added convenience of full visual display, high accuracy and stability plus operational flexibility. Order one soon. You will be delighted with it.

## TIMEKEEPER

P.O. Box 835, Great Neck, N.Y. 11021

Please send me \_\_\_\_\_ Model T-1 Timekeeper Electronic StopClock(s) at \$185.00. N.Y.S. residents add 7% sales tax. Add \$1.00 shipping per order. I enclose \$ \_\_\_\_\_

Name \_\_\_\_\_

Address \_\_\_\_\_

City \_\_\_\_\_

State \_\_\_\_\_ Zip \_\_\_\_\_

# DL42

It does more  
than just reach.

It helps you to  
better sound.  
Every take.  
Every day.  
Anywhere.

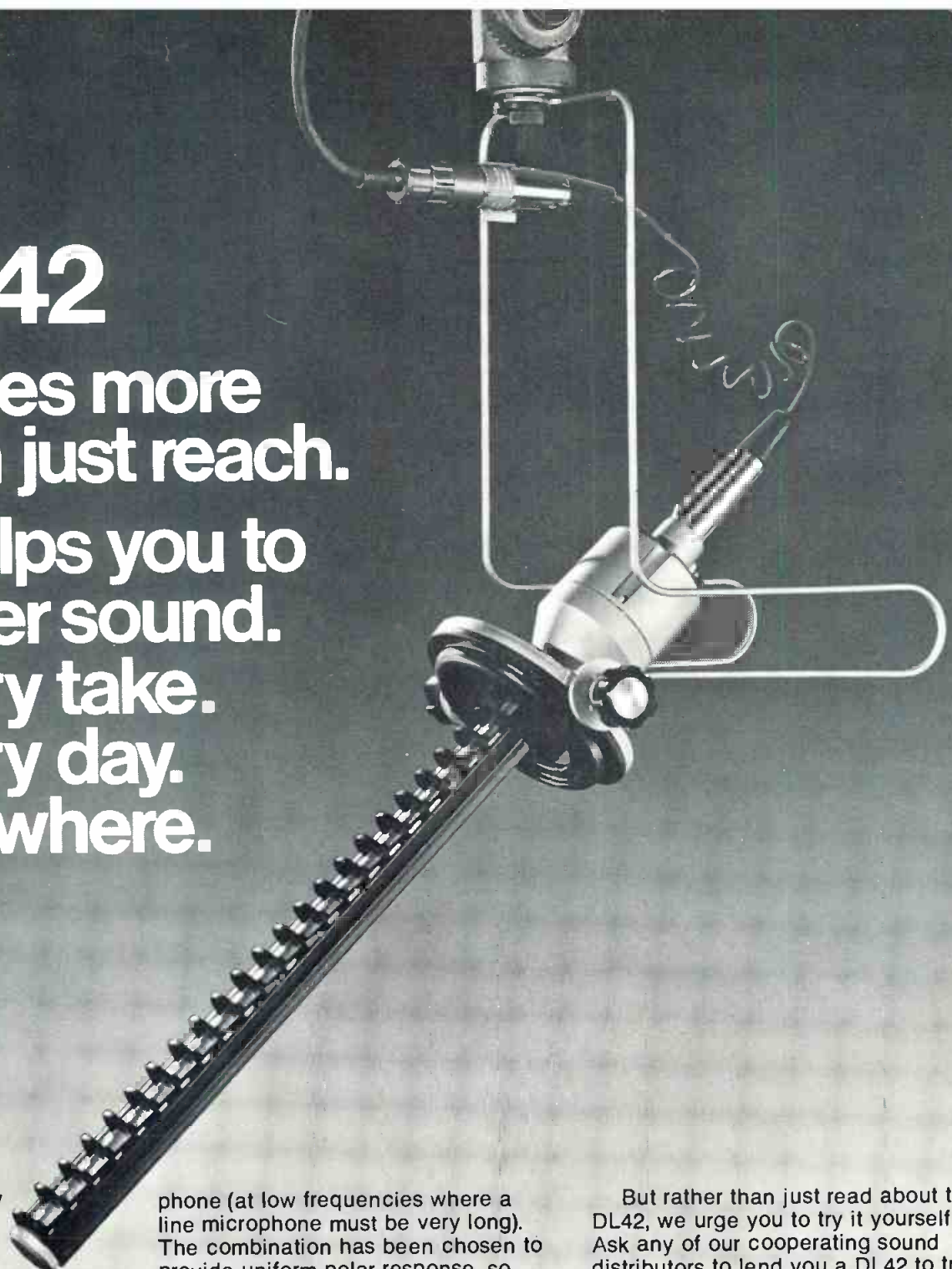

Since 1962 when the E-V Model 642 earned an Academy Award certificate for contributions to motion picture sound, there have been a lot of attempts to better this pioneering design.

Admittedly, some similar-appearing microphones were lighter and a bit smaller. But often it was at the expense of uniform polar response and wide range. Now there's a long reach microphone that's both smaller and lighter, yet maintains wide range response even off mike.

It's the E-V DL42.

Weight has been reduced to 1/4 of the 642... even less than most highly-directional condenser microphones. And size has been shaved wherever possible. The DL42 is a unique combination of line microphone (at the high frequencies) and cardioid micro-

phone (at low frequencies where a line microphone must be very long). The combination has been chosen to provide uniform polar response, so important to consistent sound quality. Off-mike pickups even sound good (although lower in level), a particular advantage to documentary units and free-wheeling shows where the unexpected is always happening.

The good pickup quality off axis has another practical benefit in the studio. Because maximum rejection is at the sides (where most of the noise comes from) you can work at a remarkable distance when necessary. So when a long shot is called for, the DL42 can be moved upward and cover the entire area with good quality and level. In fact the DL42 is more like a *super-super-cardioid*. And it covers with less racking and panning of the microphone than you ever needed before.

But rather than just read about the DL42, we urge you to try it yourself. Ask any of our cooperating sound distributors to lend you a DL42 to try on your next production. No cost or obligation to serious professional users. Write today for a DL42 technical data sheet. Good reach with good sound. We think you'll like what you hear.



**Electro-Voice**<sup>®</sup>

a **Gulton**  
COMPANY

Model DL42 Cardiine® Dynamic unidirectional microphone including shock-mounted bail, noise-isolating coil cord, screw-on handle for hand-held use, Acoustifoam™ 2-piece windscreen, and carrying case, \$300 suggested professional net.

ELECTRO-VOICE, INC., Dept. 631BD, 686 Cecil Street, Buchanan, Michigan 49107

Circle 10 on Reader Service Card  
[www.americanradiohistory.com](http://www.americanradiohistory.com)